

## Toothed belt axes EGC-HD-TB, with heavy-duty guide

**FESTO**

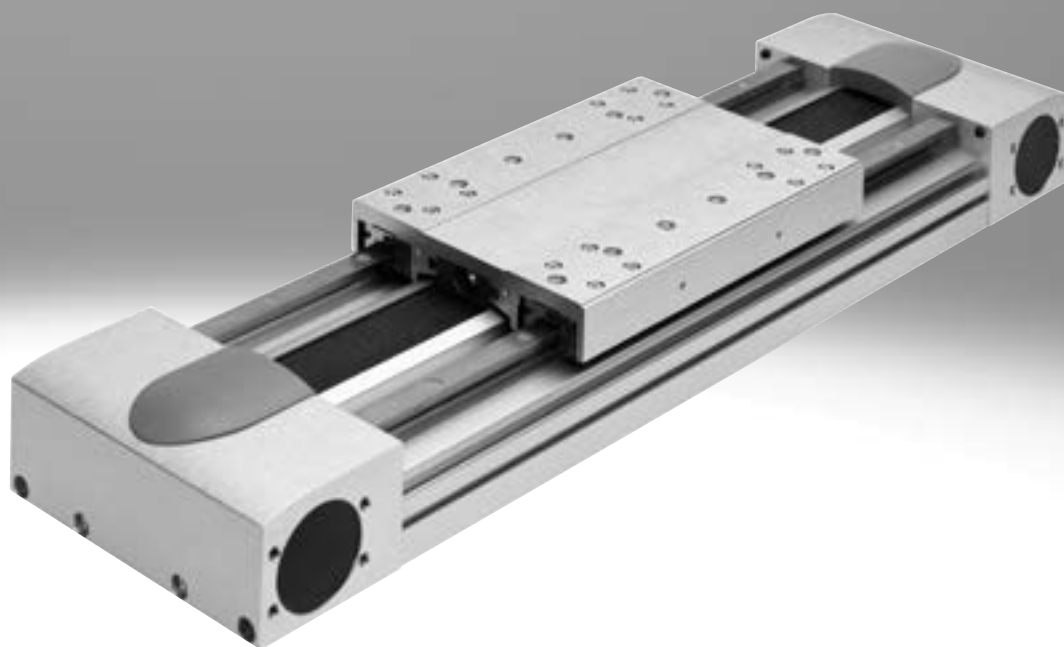

## Selection aid

### Overview of toothed belt and spindle axes

#### Toothed belt axes

- Speeds of up to 10 m/s
- Acceleration of up to 50 m/s<sup>2</sup>
- Repetition accuracy of up to ±0.08 mm
- Strokes of up to 8500 mm (longer strokes on request)
- Flexible motor mountings

#### Spindle axes

- Speeds of up to 2 m/s
- Acceleration of up to 20 m/s<sup>2</sup>
- Repetition accuracy of up to ±0.003 mm
- Strokes of up to 3000 mm

#### Coordinate system

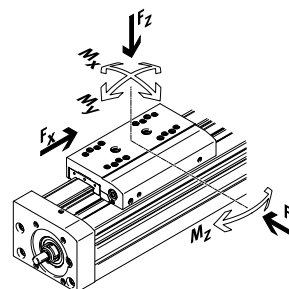

#### Toothed belt axes

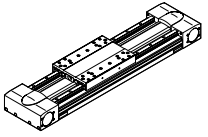
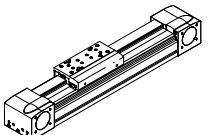
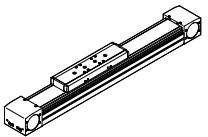
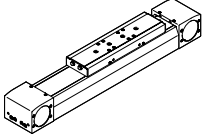
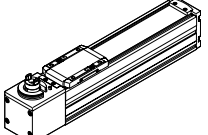
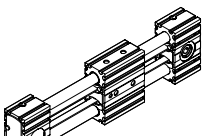
Type	F <sub>x</sub> [N]	v [m/s]	M <sub>x</sub> [Nm]	M <sub>y</sub> [Nm]	M <sub>z</sub> [Nm]	Characteristics
<b>Heavy-duty recirculating ball bearing guide</b>						
<b>EGC-HD-TB</b>						
	450 1000 1800	3 5 5	140 300 900	275 500 1450	275 500 1450	<ul style="list-style-type: none"> <li>• Flat drive unit with rigid, closed profile</li> <li>• Precision DUO guide rail with high load capacity</li> <li>• Ideal as a base axis for linear gantries and cantilever axes</li> </ul>
<b>Recirculating ball bearing guide</b>						
<b>EGC-TB-KF</b>						
	50 100 350 800 2500	3 5 5 5 5	3.5 16 36 144 529	10 132 228 680 1820	10 132 228 680 1820	<ul style="list-style-type: none"> <li>• Rigid, closed profile</li> <li>• Precision guide rail with high load capacity</li> <li>• Small drive pinions reduce required driving torque</li> <li>• Space-saving position sensing</li> </ul>
<b>ELGA-TB-KF</b>						
	350 800 1300 2000	5 5 5 5	16 36 104 167	132 228 680 1150	132 228 680 1150	<ul style="list-style-type: none"> <li>• Internal guide and toothed belt</li> <li>• Precision guide rail with high load capacity</li> <li>• Guide and toothed belt protected by cover strip</li> <li>• High feed forces</li> </ul>
<b>ELGA-TB-KF-F1</b>						
	260 600 1000	5 5 5	16 36 104	132 228 680	132 228 680	<ul style="list-style-type: none"> <li>• Suitable for use in the food zone</li> <li>• "Clean look": smooth, easy-to-clean surfaces</li> <li>• Internal guide and toothed belt</li> <li>• Precision guide rail with high load capacity</li> <li>• Guide and toothed belt protected by cover strip</li> </ul>
<b>ELGC-TB-KF</b>						
	75 120 250	1.2 1.5 1.5	5.5 29.1 59.8	4.7 31.8 56.2	4.7 31.8 56.2	<ul style="list-style-type: none"> <li>• Internal guide and toothed belt</li> <li>• Precision guide rail with high load capacity</li> <li>• Guide and toothed belt protected by cover strip</li> </ul>
<b>ELGR-TB</b>						
	50 100 350	3 3 3	2.5 5 15	20 40 124	20 40 124	<ul style="list-style-type: none"> <li>• Cost-optimised rod guide</li> <li>• Ready-to-install unit</li> <li>• Linear ball bearings with high load capacity for dynamic operation</li> </ul>

## Selection aid

## Overview of toothed belt and spindle axes

## Toothed belt axes

- Speeds of up to 10 m/s
- Acceleration of up to  $50 \text{ m/s}^2$
- Repetition accuracy of up to  $\pm 0.08 \text{ mm}$
- Strokes of up to 8500 mm (longer strokes on request)
- Flexible motor mountings

## Spindle axes

- Speeds of up to 2 m/s
- Acceleration of up to  $20 \text{ m/s}^2$
- Repetition accuracy of up to  $\pm 0.003 \text{ mm}$
- Strokes of up to 3000 mm

## Coordinate system

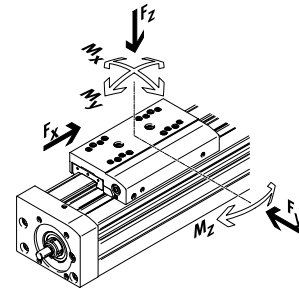

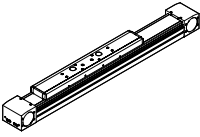
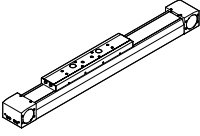
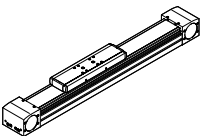
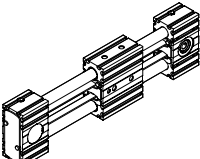
Toothed belt axes						
Type	$F_x$ [N]	$v$ [m/s]	$M_x$ [Nm]	$M_y$ [Nm]	$M_z$ [Nm]	Characteristics
<b>Roller bearing guide</b>						
<b>ELGA-TB-RF</b>						
	350 800 1300	10 10 10	11 30 100	40 180 640	40 180 640	<ul style="list-style-type: none"> <li>• Heavy-duty roller bearing guide</li> <li>• Guide and toothed belt protected by cover strip</li> <li>• Speeds of up to 10 m/s</li> <li>• Lower weight than axes with guide rails</li> </ul>
<b>ELGA-TB-RF-F1</b>						
	260 600 1000	10 10 10	8.8 24 80	32 144 512	32 144 512	<ul style="list-style-type: none"> <li>• Suitable for use in the food zone</li> <li>• "Clean look": smooth, easy-to-clean surfaces</li> <li>• Heavy-duty roller bearing guide</li> <li>• Guide and toothed belt protected by cover strip</li> <li>• Lower weight than axes with guide rails</li> </ul>
<b>Plain-bearing guide</b>						
<b>ELGA-TB-G</b>						
	350 800 1300	5 5 5	5 10 120	30 60 120	10 20 40	<ul style="list-style-type: none"> <li>• Guide and toothed belt protected by cover strip</li> <li>• For simple handling tasks</li> <li>• As a drive component for external guides</li> <li>• Insensitive to harsh ambient conditions</li> </ul>
<b>ELGR-TB-GF</b>						
	50 100 350	1 1 1	1 2.5 1	10 20 40	10 20 40	<ul style="list-style-type: none"> <li>• Cost-optimised rod guide</li> <li>• Ready-to-install unit</li> <li>• Heavy-duty plain bearings for use in harsh ambient conditions</li> </ul>

## Selection aid

### Overview of toothed belt and spindle axes

#### Toothed belt axes

- Speeds of up to 10 m/s
- Acceleration of up to 50 m/s<sup>2</sup>
- Repetition accuracy of up to ±0.08 mm
- Strokes of up to 8500 mm (longer strokes on request)
- Flexible motor mountings

#### Spindle axes

- Speeds of up to 2 m/s
- Acceleration of up to 20 m/s<sup>2</sup>
- Repetition accuracy of up to ±0.003 mm
- Strokes of up to 3000 mm

#### Coordinate system

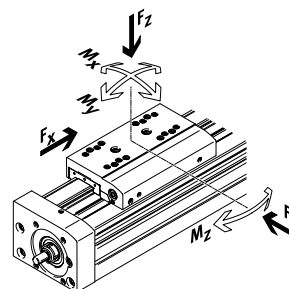

### Spindle axes

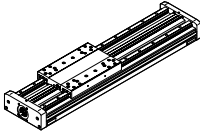
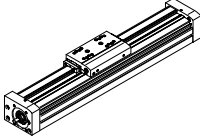
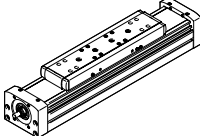
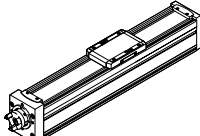
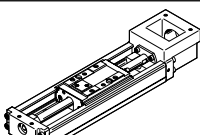
Type	F <sub>x</sub> [N]	v [m/s]	M <sub>x</sub> [Nm]	M <sub>y</sub> [Nm]	M <sub>z</sub> [Nm]	Characteristics
<b>Heavy-duty recirculating ball bearing guide</b>						
<b>EGC-HD-BS</b>						
	400 650 1500	0.5 1.0 1.5	140 300 900	275 500 1450	275 500 1450	<ul style="list-style-type: none"> <li>• Flat drive unit with rigid, closed profile</li> <li>• Precision DUO guide rail with high load capacity</li> <li>• Ideal as a base axis for linear gantries and cantilever axes</li> </ul>
<b>Recirculating ball bearing guide</b>						
<b>EGC-BS-KF</b>						
	400 650 1500 3000	0.5 1.0 1.5 2.0	16 36 144 529	132 228 680 1820	132 228 680 1820	<ul style="list-style-type: none"> <li>• Rigid, closed profile</li> <li>• Precision guide rail with high load capacity</li> <li>• For the highest requirements in terms of feed force and accuracy</li> <li>• Space-saving position sensing</li> </ul>
<b>ELGA-BS-KF</b>						
	650 1600 3400 6400	0.5 1.0 1.5 2.0	16 36 104 167	132 228 680 1150	132 228 680 1150	<ul style="list-style-type: none"> <li>• Internal guide and ball screw drive</li> <li>• Precision guide rail with high load capacity</li> <li>• For the highest requirements in terms of feed force and accuracy</li> <li>• Guide and ball screw protected by cover strip</li> <li>• Space-saving position sensing</li> </ul>
<b>ELGC-BS-KF</b>						
	40 100 200 350	0.6 0.6 0.8 1.0	1.3 5.5 29.1 59.8	1.1 4.7 31.8 56.2	1.1 4.7 31.8 56.2	<ul style="list-style-type: none"> <li>• Internal guide and ball screw drive</li> <li>• Guide and ball screw protected by cover strip</li> <li>• Space-saving position sensing</li> </ul>
<b>EGSK</b>						
	57 133 184 239 392	0.33 1.10 0.83 1.10 1.48	13 28.7 60 79.5 231	3.7 9.2 20.4 26 77.3	3.7 9.2 20.4 26 77.3	<ul style="list-style-type: none"> <li>• Spindle axes with maximum precision, compactness and rigidity</li> <li>• Recirculating ball bearing guide and ball screw drive without caged ball bearings</li> <li>• Standard designs in stock</li> </ul>

## Key features

### At a glance

- New heavy-duty design for:
  - Maximum loads and torques
  - High feed forces and speeds
  - Long service life
- Precision DUO guide rail with high load capacity
- Ideal as a basic axis for linear gantries and cantilever axes
- Space-saving position sensing with proximity switch in the profile slot is possible
- Toothed belt material can be selected from:
  - Chloroprene rubber for long service life
  - Coated PU with steel reinforcement cords for long service life and resistance to certain cooling to certain cooling lubricants
- Wide range of options for mounting on drives
- In addition to the technical data, the toothed belt axis impresses with its excellent price/performance ratio

### Flexible motor mounting

The motor position can be freely selected on 4 sides and can be changed at any time.



### Flat unit with rigid, closed profile

EGC-HD-125

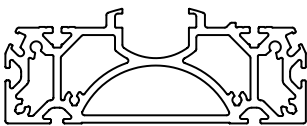

EGC-HD-160

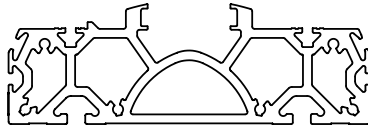

EGC-HD-220

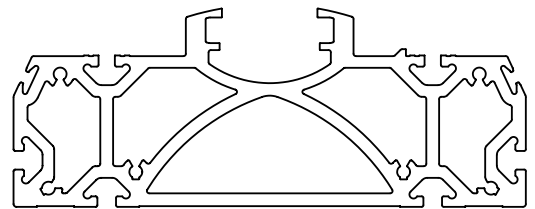

### Characteristic values of the axes

The specifications shown in the table are maximum values.

The precise values for each of the variants can be found in the relevant data sheet in the catalogue.

Design	Size	Working stroke [mm]	Speed [m/s]	Repetition accuracy [mm]	Feed force [N]	Guide characteristics				
						Forces and torques				
						F <sub>y</sub> [N]	F <sub>z</sub> [N]	M <sub>x</sub> [Nm]	M <sub>y</sub> [Nm]	M <sub>z</sub> [Nm]
<b>Recirculating ball bearing guide</b>										
	125	50 ... 3000	3	±0.08	450	3650	3650	140	275	275
	160	50 ... 5000	5	±0.08	1000	5600	5600	300	500	500
	220	50 ... 4750	5	±0.1	1800	13000	13000	900	1450	1450

### Note

Engineering software

Electric Motion Sizing

[www.festo.com/x/electric-motion-sizing](http://www.festo.com/x/electric-motion-sizing)

## Key features

### Slide variants

Standard slide

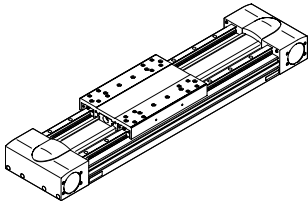

Standard slide, protected

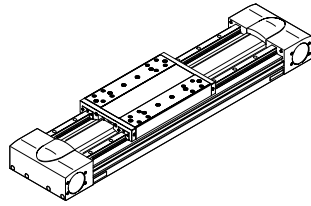

With additional slide

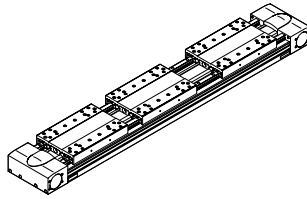

### Guide options

→ Page 19

With central lubrication

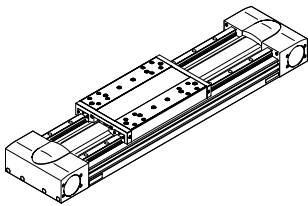

- The lubrication adapters enable the guide to be permanently lubricated using semi or fully automatic relubrication devices
- The adapters are suitable for oils and greases
- All lubrication connections must be connected

### Displacement encoder

→ Page 12

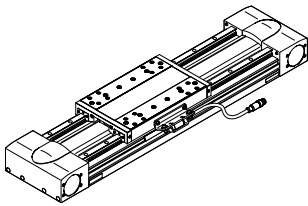

The position of the slide can be sensed directly when using the incremental displacement encoder. This means that all elasticities of the drivetrain can be detected and corrected by the motor controller.

### Complete system comprising toothed belt axis, motor, motor controller and motor mounting kit

Toothed belt axis with recirculating ball bearing guide



Motor

→ Page 28



Servo motor:  
EMMT-AS, EMME-AS



Stepper motor:  
EMMS-ST  
Gear unit:  
EMGA

Servo drives



Servo drive:  
CMMT-AS  
Servo drive for extra-low voltage:  
CMMT-ST

Motor mounting kit

→ Page 28

Axial kit



Kit comprising:

- Motor flange
- Coupling housing
- Coupling
- Screws

### Note

A range of specially adapted complete solutions is available for the toothed belt axis EGC and the motors.

## Type codes

<b>001</b>	Series	
<b>EGC</b>	Electric linear axis	
<b>002</b>	Guide	
<b>HD</b>	Heavy-duty guide	
<b>003</b>	Size	
<b>125</b>	125	
<b>160</b>	160	
<b>220</b>	220	
<b>004</b>	Stroke range [mm]	
<b>...</b>	50 ... 5000	
<b>005</b>	Drive system	
<b>TB</b>	Toothed belt	
<b>006</b>	Stroke reserve [mm]	
<b>...</b>	1 ... 999	
<b>007</b>	Slide	
<b>GK</b>	Standard slide	
<b>GP</b>	Standard slide, protected	
<b>008</b>	Additional slide left	
	None	
<b>KL</b>	Additional slide, standard, left	
<b>009</b>	Additional slide, right	
	None	
<b>KR</b>	Additional slide standard, right	
<b>010</b>	Toothed belt material	
	Chloroprene rubber	
<b>PU2</b>	Coated PU	
<b>011</b>	Lubrication function	
	None	
<b>C</b>	Lubrication adapter	
<b>012</b>	Displacement encoder	
	None	
<b>M1</b>	With displacement encoder, incremental, resolution 2.5 µm	
<b>M2</b>	With displacement encoder, incremental, resolution 10 µm	
<b>013</b>	Displacement encoder attachment position	
	None	
<b>F</b>	Front	
<b>B</b>	Rear	
<b>014</b>	Profile mounting	
<b>...M</b>	1 - 50 pieces	
<b>015</b>	Slot cover, mounting slot	
	Without	
<b>...B</b>	1 - 50 pieces	

<b>016</b>	Slot cover, sensor slot	
	Without	
<b>...S</b>	1 - 50 pieces	
<b>017</b>	Slot nut, mounting slot	
	Without	
<b>...Y</b>	1 ... 99 pieces	
<b>018</b>	Proximity switch, inductive, slot 8, PNP, N/O contact, cable 7.5 m	
	None	
<b>...X</b>	1 ... 6 pieces	
<b>019</b>	Proximity switch, inductive, slot 8, N/C contact, cable 7.5 m	
<b>...Z</b>	1 ... 6 pieces	
<b>020</b>	Emergency buffer with retaining bracket	
	Without	
<b>...A</b>	1 ... 2 pieces	
<b>021</b>	Shock absorber with retaining bracket	
	None	
<b>...C</b>	1 ... 2 pieces	
<b>022</b>	Proximity switch, inductive, M8, PNP, N/O contact, cable 2.5 m	
	Without	
<b>...O</b>	1 ... 99 pieces	
<b>023</b>	Proximity switch, inductive, M8, PNP, N/C contact, cable 2.5 m	
	None	
<b>...P</b>	1 ... 99 pieces	
<b>024</b>	Proximity switch, inductive, M8, PNP, N/O contact, M8 plug	
	Without	
<b>...W</b>	1 ... 99 pieces	
<b>025</b>	Proximity switch, inductive, M8, PNP, N/C contact, M8 plug	
	None	
<b>...R</b>	1 ... 99 pieces	
<b>026</b>	Connecting cable 2.5 m, M8, 3-wire	
	None	
<b>...V</b>	1 ... 99 pieces	
<b>027</b>	Cable clip	
	None	
<b>10CL</b>	10 pieces	
<b>20CL</b>	20 pieces	
<b>30CL</b>	30 pieces	
<b>40CL</b>	40 pieces	
<b>50CL</b>	50 pieces	
<b>60CL</b>	60 pieces	
<b>70CL</b>	70 pieces	
<b>80CL</b>	80 pieces	
<b>90CL</b>	90 pieces	

Peripherals overview

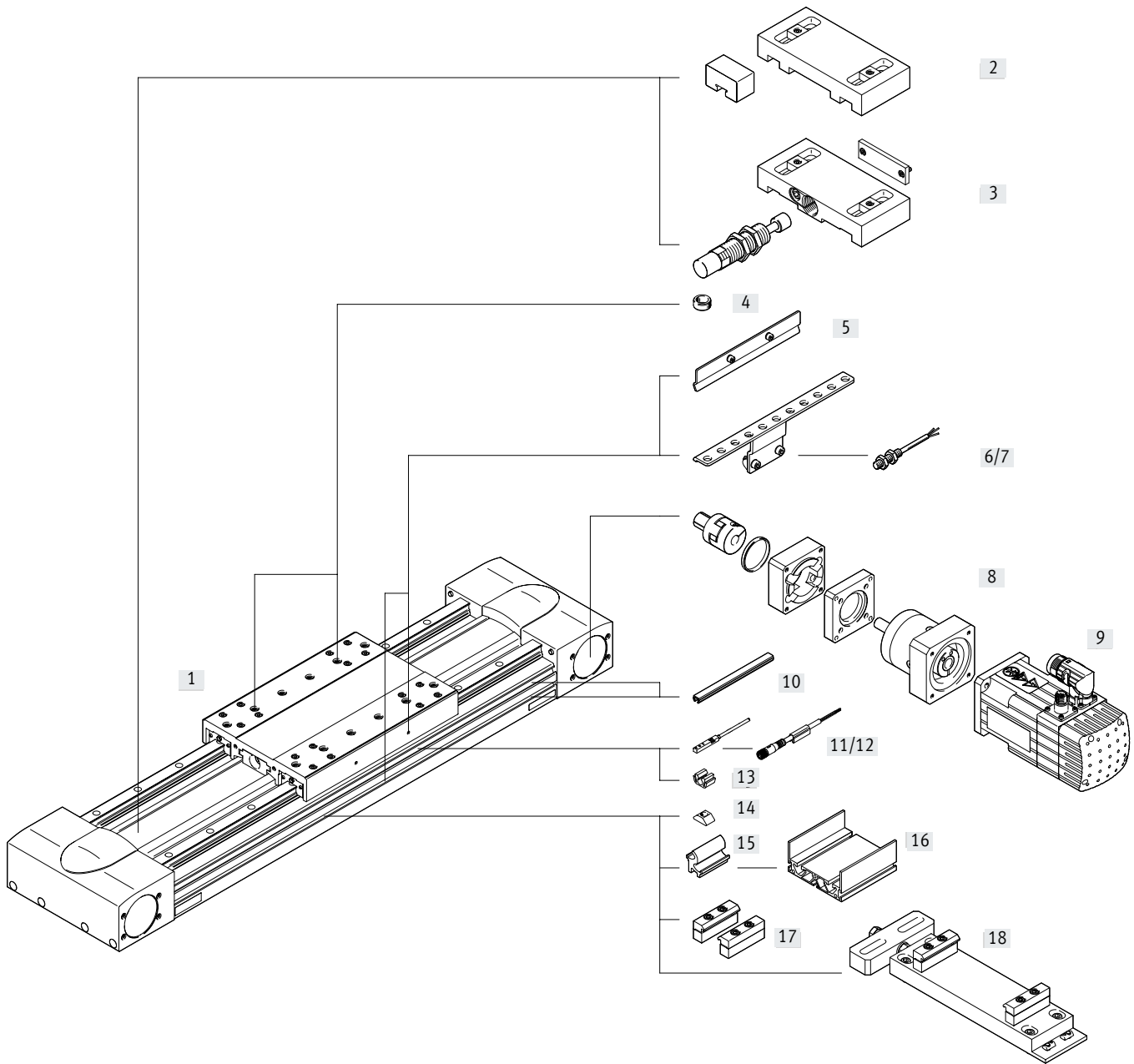





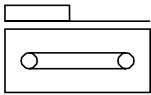

## Peripherals overview

Variants and accessories			
	Type/order code	Description	→ Page/Internet
[1]	Toothed belt axis EGC-HD-TB	Electric drive	10
[2]	Emergency buffer with retaining bracket A	For avoiding damage at the end stop in the event of a malfunction	35
[3]	Shock absorber with retaining bracket C	For avoiding damage at the end stop in the event of a malfunction	35
[4]	Centring pin/sleeve ZBS, ZBH	<ul style="list-style-type: none"> <li>For centring loads and attachments on the slide</li> <li>Included in the scope of delivery: <ul style="list-style-type: none"> <li>For size 125: 2x ZBS-5, 2x ZBH-9</li> <li>For size 160, 220: 2x ZBH-9</li> </ul> </li> </ul>	35
[5]	Switch lug X, Z, O, P, W, R	For sensing the slide position	33
[6]	Sensor bracket O, P, W, R	Adapter for mounting the inductive proximity switches (round design) on the axis	34
[7]	Proximity switch, M8 O, P, W, R	<ul style="list-style-type: none"> <li>Inductive proximity switch, round design</li> <li>The order code O, P, W, R includes 1 switch lug and max. 2 sensor brackets in the scope of delivery</li> </ul>	37
[8]	Axial kit EAMM	For axial motor mounting (comprising: coupling, coupling housing and motor flange)	28
[9]	Motor EMME, EMMS	Motors specially matched to the axis, with gear unit, with or without brake	28
[10]	Slot cover B, S	<ul style="list-style-type: none"> <li>For protection against contamination</li> </ul>	35
[11]	Proximity switch, T-slot X, Z	<ul style="list-style-type: none"> <li>Inductive proximity switch, for T-slot</li> <li>The order code X, Z includes 1 switch lug in the scope of delivery</li> </ul>	36
[12]	Connecting cable V	For proximity switch (order code W and R)	37
[13]	Clip CL	For mounting the proximity switch cable in the slot	35
[14]	Slot nut Y	For mounting attachments	35
[15]	Adapter kit DHAM	For mounting the support profile on the axis	36
[16]	Support profile HMIA	For mounting and guiding an energy chain	36
[17]	Profile mounting M	For mounting the axis on the profile	31
[18]	Adjusting kit EADC-E16	For mounting the axis on a vertical surface. Once mounted, the axis can be aligned horizontally	32

Data sheet



-  Size  
125 ... 220
-  Stroke length  
50 ... 5000 mm
-  [www.festo.com](http://www.festo.com)

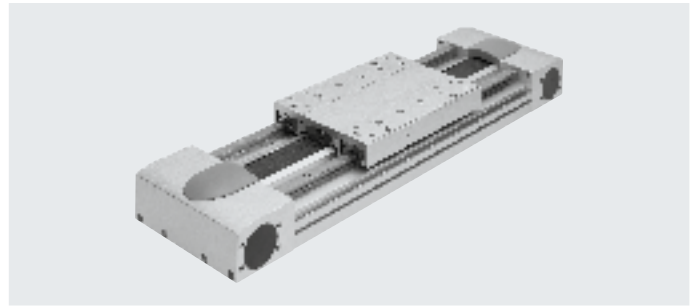

General technical data				
Size		125	160	220
Design		Electromechanical axis with toothed belt		
Guide		Recirculating ball bearing guide		
Mounting position		Any		
Working stroke	[mm]	50 ... 3000	50 ... 5000	50 ... 4750
Max. feed force $F_x$	[N]	450	1000	1800
Max. no-load torque <sup>1)</sup>	[Nm]	1.1	2.1	4.1
Max. no-load resistance to shifting <sup>1)</sup>	[N]	67.75	105.5	123.8
Max. driving torque	[Nm]	7.2	20	59.58
Max. speed				
EGC -...- GK	[m/s]	3	5	
EGC -...- GP	[m/s]	-	3	
Max. acceleration	[m/s <sup>2</sup> ]	40	50	
Repetition accuracy	[mm]	±0.08		±0.1

1) At 0.2 m/s

Operating and environmental conditions		
Ambient temperature	[°C]	-10 ... +60
Degree of protection		IP40
Duty cycle	[%]	100

Weight [g]				
Size		125	160	220
Basic weight with 0 mm stroke <sup>1)</sup>		4720	9050	25510
Additional weight per 10 mm stroke		73	107	210
Slide				
EGC -...- GK		1218	2571	6317
EGC-...-GK-C		1334	2813	6785
EGC -...- GP		-	2643	6417
Additional slide				
EGC -...- GK		1026	2022	5498
EGC-...-GK-C		1142	2264	5996
EGC -...- GP		-	2134	5598

1) Incl. slide

## Data sheet

Toothed belt				
Size		125	160	220
Pitch	[mm]	3	5	8
Width	[mm]	30.3	40.0	50.5
Elongation <sup>1)</sup>				
EGC...	[%]	0.178	0.161	0.173
EGC...-PU2	[%]	0.085	0.094	0.068
Effective diameter	[mm]	32.47	39.79	66.21
Feed constant	[mm/rev]	102	125	208

1) At max. feed force

Mass moment of inertia				
Size		125	160	220
$J_0$	[kg cm <sup>2</sup> ]	4.639	14.49	108.99
$J_H$ per metre stroke	[kg cm <sup>2</sup> /m]	0.38	1.267	6.269
$J_L$ per kg payload	[kg cm <sup>2</sup> /kg]	2.635	3.96	10.96
$J_W$ Additional slide	[kg cm <sup>2</sup> ]	3.3	11.734	80.66

The mass moment of inertia  $J_A$  of the entire axis is calculated as follows:

$$J_A = J_0 + J_W + J_H \times \text{working stroke [m]} + J_L \times m_{\text{payload [kg]}}$$

## Materials

Sectional view

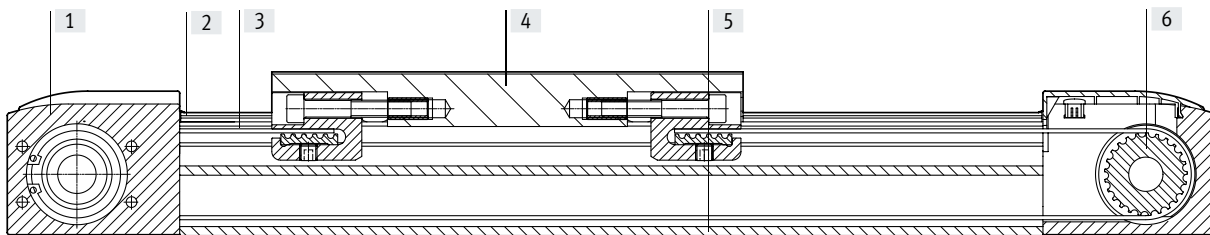

Axis		
[1]	Drive cover	Anodised wrought aluminium alloy
[2]	Guide rail	Coated and corrosion-resistant steel
[3]	Toothed belt	
	EGC...	Polychloroprene with glass cord and nylon coating
	EGC...-PU2	Polyurethane with steel cord and nylon cover
[4]	Slide	Anodised wrought aluminium alloy
[5]	Profile	Anodised wrought aluminium alloy
[6]	Toothed belt pulley	High-alloy stainless steel
	Note on materials	RoHS-compliant
		Contains paint-wetting impairment substances

## Data sheet

Technical data – Displacement encoder		EGC...-M1		EGC...-M2		Dimensions → page 25
Type						
Resolution	[μm]	2.5		10		
Max. travel speed with displacement encoder	[m/s]	4		4		
Encoder signal		5 V TTL; A/A, B/B; reference signal (N/N) cyclically every 5 mm (zero pulse)				
Signal output		Line driver, alternating, resistant to sustained short circuit				
Electrical connection		8-pin plug, round design, M12				
Cable length	[mm]	160				
Operating and environmental conditions – Displacement encoder system						
Ambient temperature	[°C]	-10 ... +70				
Degree of protection		IP64				
CE marking (see declaration of conformity)		To EU EMC Directive <sup>1)</sup>				

- 1) For information about the area of use, see the EC declaration of conformity at: [www.festo.com/sp](http://www.festo.com/sp) → Certificates.  
If the devices are subject to usage restrictions in residential, commercial or light-industrial environments, further measures for the reduction of the emitted interference may be necessary.

## Application information

- The displacement encoder contains paint-wetting impairment substances.
- The toothed belt axis with displacement encoder is not designed for the following application examples:

- Magnetic field

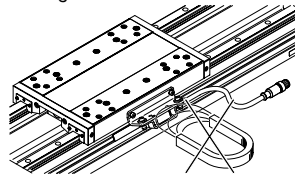

- Welding application

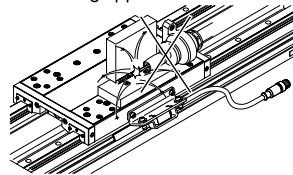

## Data sheet

### Characteristic load values

The indicated forces and torques refer to the slide surface. The point of application of force is the point where the centre of the guide and the longitudinal centre of the slide intersect.

These values must not be exceeded during dynamic operation. Special attention must be paid to the deceleration phase.

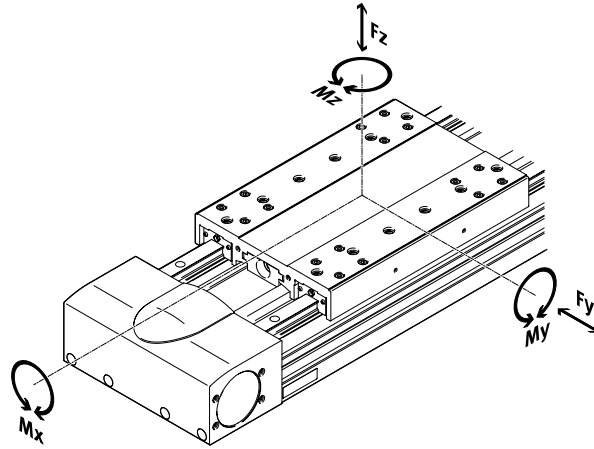

#### Max. permissible forces and torques for a service life of 5000 km

Size		125	160	220
$F_{y_{max}}$	[N]	3650	5600	13000
$F_{z_{max}}$	[N]	3650	5600	13000
$M_{x_{max}}$	[Nm]	140	300	900
$M_{y_{max}}$	[Nm]	275	500	1450
$M_{z_{max}}$	[Nm]	275	500	1450



#### Note

For a guide system to have a service life of 5000 km, the load comparison factor must have a value of  $f_v \leq 1$ , based on the maximum permissible forces and torques for a service life of 5000 km.

If the axis is subjected to two or more of the indicated forces and torques simultaneously, the following equation must be satisfied in addition to the indicated maximum loads:

Calculating the load comparison factor:

$$f_v = \frac{|F_{y1}|}{F_{y2}} + \frac{|F_{z1}|}{F_{z2}} + \frac{|M_{x1}|}{M_{x2}} + \frac{|M_{y1}|}{M_{y2}} + \frac{|M_{z1}|}{M_{z2}} \leq 1$$

$F_1/M_1$  = dynamic value

$F_2/M_2$  = maximum value

## Data sheet

### Calculating the service life

The service life of the guide depends on the load. To be able to make a statement as to the service life of the guide, the graph below plots the load comparison factor  $f_v$  against the service life.

These values are only theoretical. You must consult your local Festo contact for a load comparison factor  $f_v$  greater than 1.5.

#### Load comparison factor $f_v$ as a function of service life

Example:

A user wants to move an X kg load. Using the formula (→ page 13) gives a value of 1.5 for the load comparison factor  $f_v$ . According to the graph, the guide would have a service life of approx. 1500 km. Reducing the acceleration reduces the  $M_z$  and  $M_y$  values. A load comparison factor  $f_v$  of 1 now gives a service life of 5000 km.

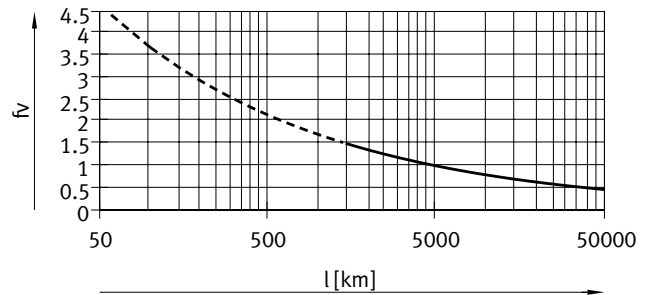

#### Note

Engineering software  
Electric Motion Sizing  
[www.festo.com/x/electric-motion-sizing](http://www.festo.com/x/electric-motion-sizing)

The engineering software can be used to calculate the guide workload for a service life of 5000 km.

$f_v > 1.5$  are only theoretical comparison values for the recirculating ball bearing guide.

### Comparison of the characteristic load values for 5000 km with dynamic forces and torques of recirculating ball bearing guides

The characteristic load values of bearing guides are standardised to ISO and JIS using dynamic and static forces and torques. These forces and torques are based on an expected service life of the guide system of 100 km to ISO or 50 km to JIS. As the characteristic load values are dependent on the service life, the maximum permissible forces and torques for a 5000 km service life cannot be compared with the dynamic forces and torques of bearing guides to ISO/JIS.

To make it easier to compare the guide capacity of linear axes EGC with bearing guides, the table below lists the theoretically permissible forces and torques for a calculated service life of 100 km. This corresponds to the dynamic forces and torques to ISO.

These 100 km values have been calculated mathematically and are only to be used for comparing with dynamic forces and torques to ISO. The drives must not be loaded with these characteristic values as this could damage the axes.

#### Max. permissible forces and torques for a theoretical service life of 100 km (from a guide perspective only)

Size		125	160	220
$F_{y_{max}}$	[N]	13447	20631	47892
$F_{z_{max}}$	[N]	13447	20631	47892
$M_{x_{max}}$	[Nm]	516	1105	3316
$M_{y_{max}}$	[Nm]	1013	1842	5342
$M_{z_{max}}$	[Nm]	1013	1842	5342

Data sheet

Max. acceleration  $a$  as a function of payload  $m$

Size 125

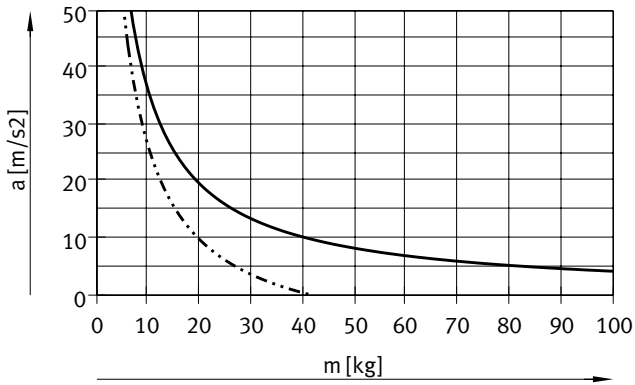

Size 160

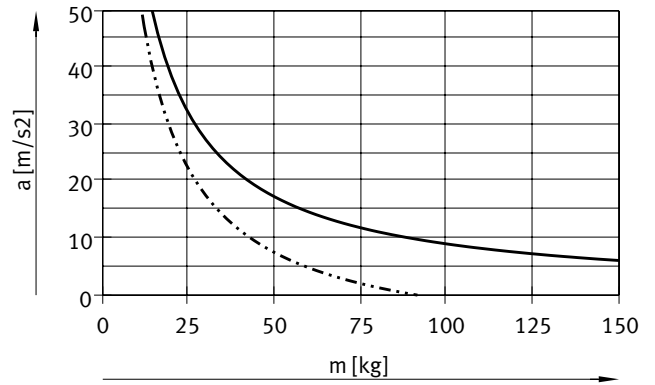

Size 220

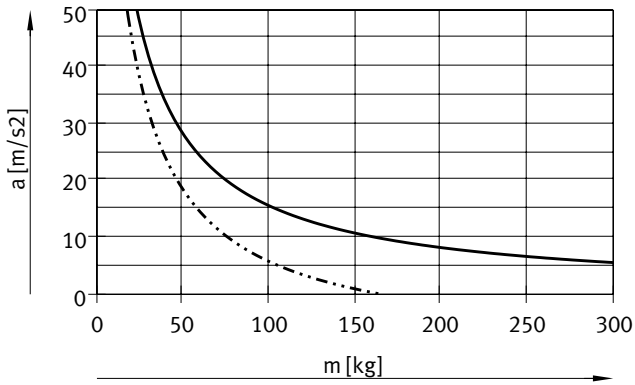

— Horizontal installed length  
 - - - Vertical installed length

Velocity  $v$  as a function of rotational speed  $n$

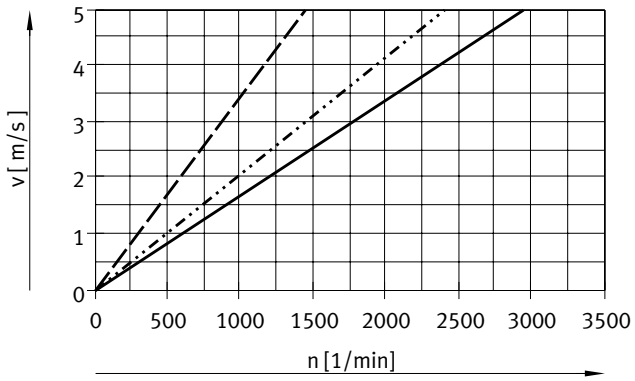

— EGC-HD-125  
 ..... EGC-HD-160  
 - - - EGC-HD-220

Data sheet

Theoretical feed force F as a function of input torque M

Size 125

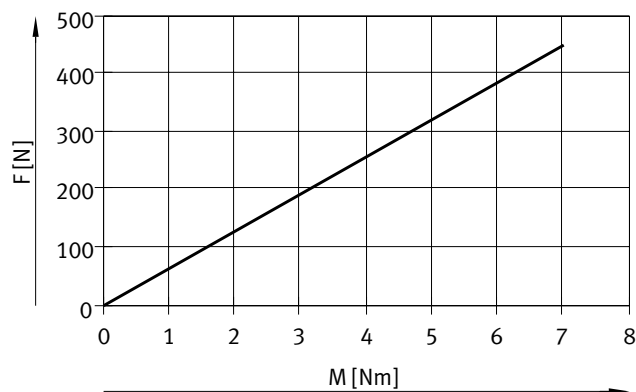

Size 160

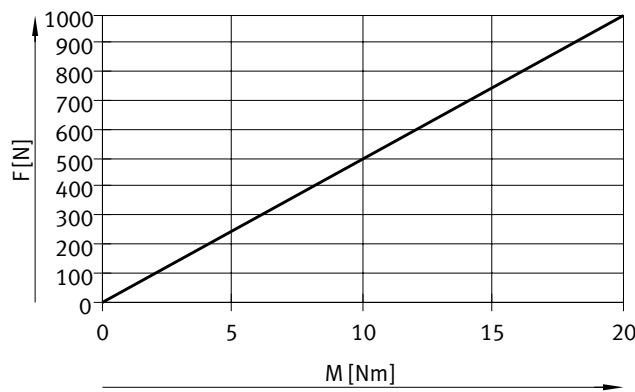

Size 220

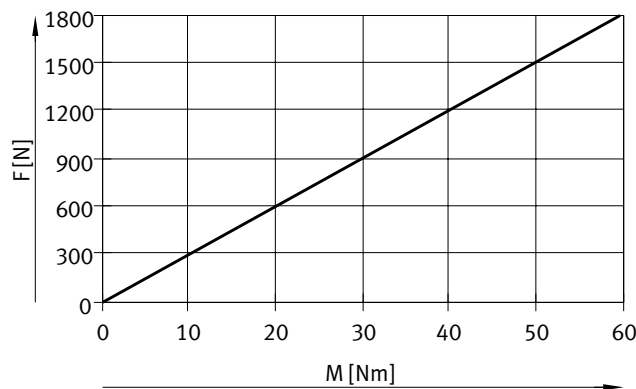

Stroke reserve

Stroke length

Stroke reserve

The selected stroke corresponds in principle to the required working stroke. The variants GK do not have a long-term lubrication unit on the guide. These variants therefore have an additional safety distance between the drive cover and slide that is not designated as part of the working stroke.

It is possible to define a safety distance (similar to that for GK) between the drive cover and slide for the variants GP using the "stroke reserve" characteristic in the modular product system. With the variants GK, the stroke reserve and safety distance are added for each end position.

- The stroke reserve length can be freely selected
- The sum of the stroke length and 2x stroke reserve must not exceed the maximum working stroke

Example:

Type:  
EGC-HD-125-500-TB-20H-...  
Working stroke = 500 mm  
2x stroke reserve = 40 mm  
  
Total stroke= 540 mm  
(540 mm = 500 mm + 2x 20 mm)

Size	125	160	220
L = safety distance with GK (per end position) [mm]	12.5	15.5	20



## Data sheet

**Working stroke reduction**

For standard slide GK/GP with additional slide KL/KR

- With a toothed belt axis with additional slide [1], the working stroke is reduced by the length of the additional slide L17 and the distance between both slides L18
- If the variant GP is ordered, the additional slide is also protected
- If the variant GK-C is ordered, the additional slide is also supplied with lubrication adapters

L16 = Slide length                      L18 = Distance between  
L17 = Additional slide length            the two slides

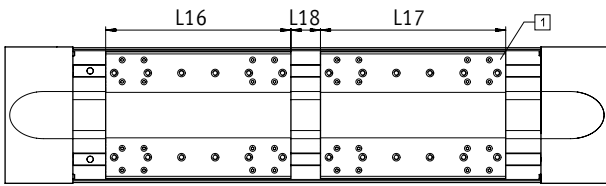
**Example:**

Type: EGC-HD-220-1000-TB-...-GP-KL/KR

L18 = 100 mm

Working stroke = 1000 mm – 328 mm – 100 mm = 572 mm

**Dimensions – Additional slide**

Size	125	160	220
Variant	GK	GK-C	GP
Length L17 [mm]	202	220	328

**Working stroke reduction per side**

With integrated emergency buffer NPE/shock absorber YSRW with shock absorber retainer EAYH-L2

- With a toothed belt axis, the working stroke is reduced by the total dimension of the emergency buffer/shock absorber and shock absorber retainer.

Size	125	160	220
With emergency buffer [mm]	65	93	98
With shock absorber [mm]	66	94	99

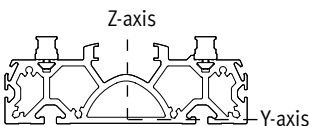
**2nd moments of area**

Size	125	160	220
I <sub>y</sub> [mm <sup>4</sup> ]	6.89x10 <sup>5</sup>	12.9x10 <sup>5</sup>	55.8x10 <sup>5</sup>
I <sub>z</sub> [mm <sup>4</sup> ]	40.9x10 <sup>5</sup>	98.9x10 <sup>5</sup>	351x10 <sup>5</sup>

## Data sheet

### Maximum permissible support span L (without profile mounting) as a function of force F

In order to limit deflection in the case of large strokes, the axis may need to be supported.

The following graphs can be used to determine the maximum permissible support span L as a function of force F acting on the axis. The deflection is  $f = 0.5 \text{ mm}$ .

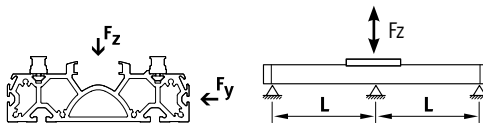

Force  $F_y$

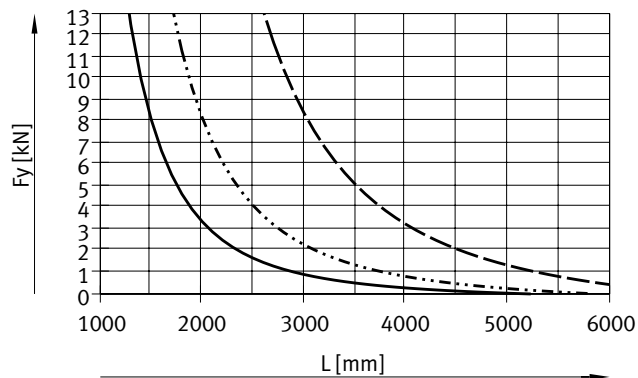

- EGC-HD-125-TB
- ⋯ EGC-HD-160-TB
- - - EGC-HD-220-TB

Force  $F_z$

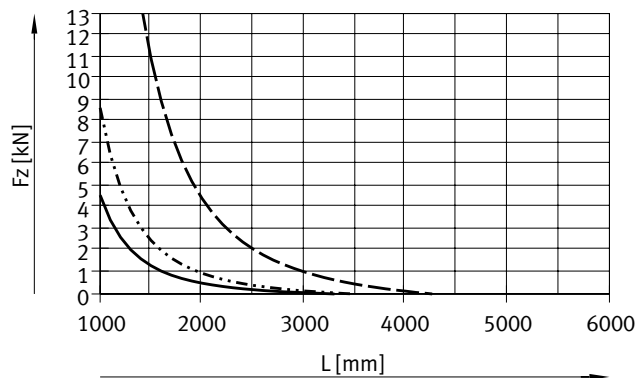

### Recommended deflection limits

Adherence to the following deflection limits is recommended so as not to impair the functionality of the axes.

Greater deformation can result in increased friction, greater wear and reduced service life.

Size	Dynamic deflection (moving load)	Static deflection (stationary load)
125 ... 220	0.05% of the axis length, max. 0.5 mm	0.1% of the axis length

## Data sheet

### Central lubrication

The lubrication adapters enable the guide of the toothed belt axis EGC-HD-TB to be permanently lubricated in applications in humid or wet ambient conditions using semi or fully automatic relubrication devices.

- For size 125, 160, 220
- The modules are suitable for oils and greases.
- The dimensions of the toothed belt axis EGC-HD-TB are the same with and without central lubrication modules.
- All lubrication connections must be connected
- There are two connection options on each side
- Can be used in combination with:
  - Standard slide GK
  - Additional slide KL, KR
- Cannot be used in combination with:
  - Standard slide, protected GP

Slide dimensions

→ page 24

Order code C in the modular product system → page 27

### Design of a central lubrication system

A central lubrication system requires various additional components. The illustration shows different options (using a hand pump, pneumatic container pump or electric container pump) required as a minimum for designing a central lubrication system. Festo does not sell these additional components; however, they can be obtained from the following companies:

- Lincoln
- Bielomatik
- SKF (Vogel)

Festo recommends these companies because they can supply all the necessary components.

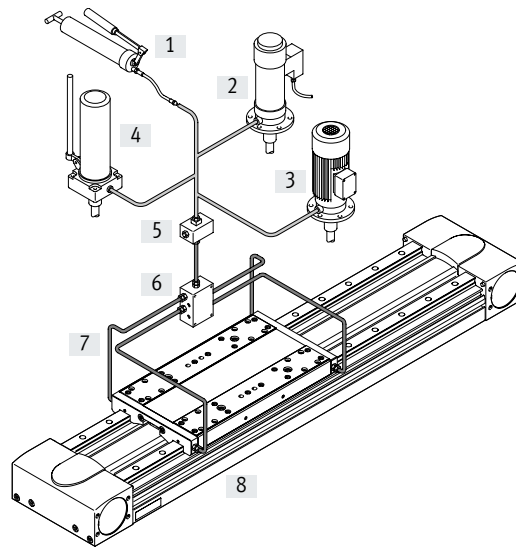

- [1] Hand pump
- [2] Pneumatic container pump
- [3] Electric container pump
- [4] Manually operated container pump
- [5] Nipple block
- [6] Distributor block
- [7] Tubing or piping
- [8] Fittings

Data sheet

Dimensions

Download CAD data → [www.festo.com](http://www.festo.com)

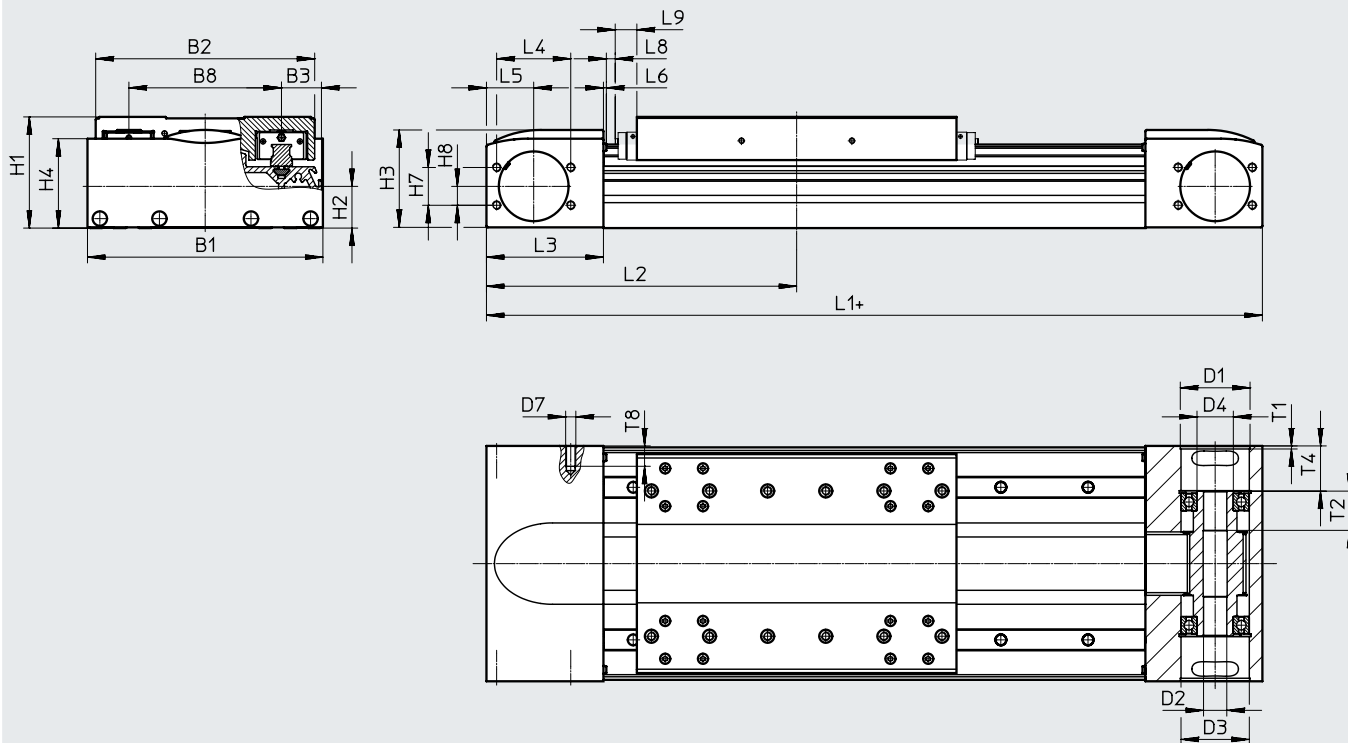

+ = plus stroke length + 2x stroke reserve

L9 With GP: dimension for long-term lubrication unit → page 16

Size	B1	B2	B3	B8	D1 ∅ H7	D2 ∅ H7	D3 ∅	D4 ∅	D7
125	124	120	21	80	43	16	42	25	M6
160	162	150.7	27.5	105	48	16	47	25	M6
220	224	204.2	40	140	80	23	75	45	M8

Size	H1	H2	H3	H4	H7	H8	L1	L2 min.	L3
125	64	26.1	55.8	50.8	24	12	346	173	57.5
160	76.5	28.7	67.5	61.5	26	13	417	208.5	80.5
220	111.5	45.2	98	91.1	59	27	576	288	115

Size	L4	L5	L6	L8	L9	T1	T2	T4	T8
125	46	27.5	1.8	2	-	2.1	27	23.65	13
160	51	32.5	2	0.55	14.9	3.1	27	31.1	14
220	76	50	2	2	18	3.1	29.5	47.5	16

Data sheet

Dimensions

Download CAD data → [www.festo.com](http://www.festo.com)

Profile

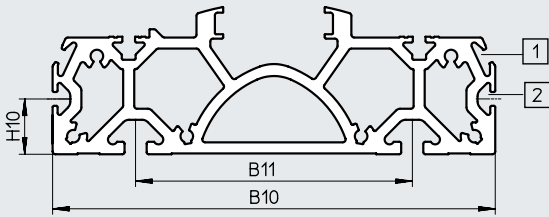

- [1] Sensor slot for proximity switch
- [2] Mounting slot for slot nut

Size	B10	B11	H10
125	122	80	20
160	160	100	20
220	220	140	20

GK – Standard slide

Size 125

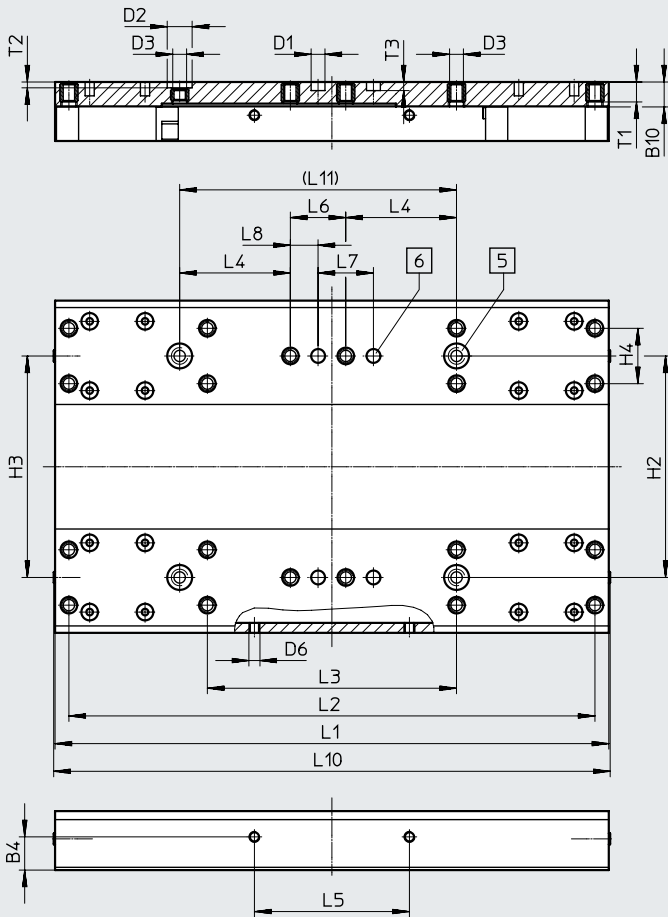

- [5] Drilled hole for centring sleeve ZBH
- [6] Drilled hole for centring pin ZBS

Size	B4	B10	D1 ∅	D2 ∅	D3	D6	H2	H3	H4	L1	L2	L3
	±0.1		H7	H7			±0.03	±0.05	±0.1	±0.1	±0.2	±0.1
125	12	9	5	9	M5	M4	80	80	20	200	190	90

Size	L4	L5	L6	L7	L8	L10	L11	T1	T2	T3
	±0.1	±0.2	±0.1	±0.03	±0.1		±0.03		+0.1	+0.1
125	40	56	20	20	10	202	100	7.8	2.1	3.1

Data sheet

Dimensions

Download CAD data → [www.festo.com](http://www.festo.com)

GK – Standard slide / GP – Standard slide, protected

Size 160

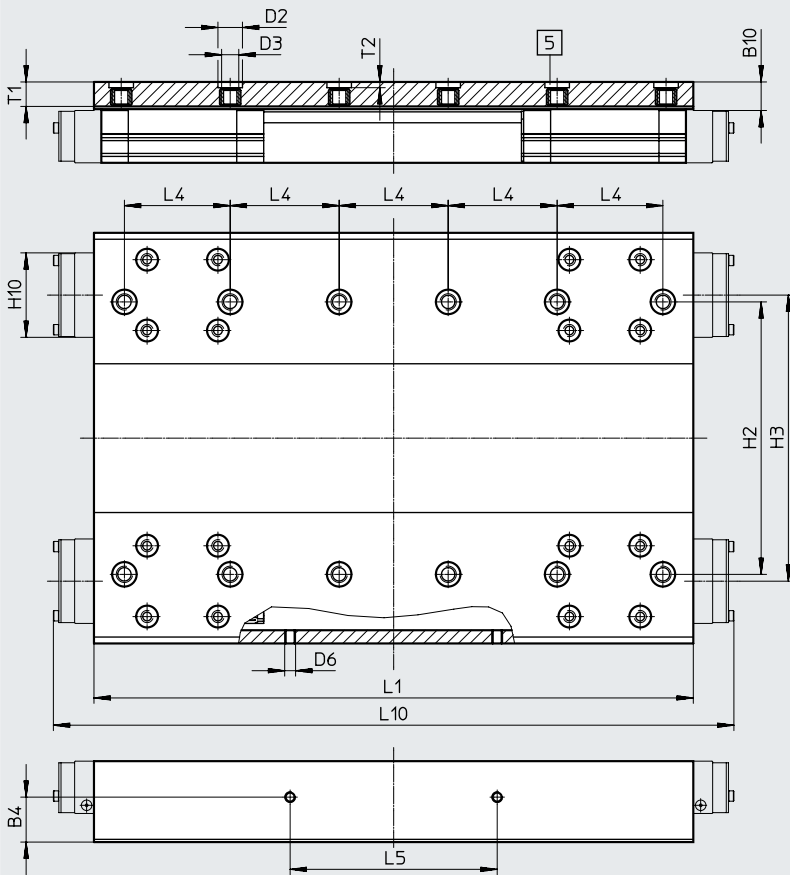

[5] Drilled hole for centring sleeve ZBH

Size	B4	B10*	D2 ∅ H7	D3	D6	H2 ±0.03	H3 ±0.05
160	16.5	10.5	9	M6	M4	100	105
Size	H10*	L1	L4	L5	L10*	T1	T2
160	31	±0.1 220	±0.03 40	±0.1 76	250	9	+0.1 2.1

\* Protected version

## Data sheet

## Dimensions

Download CAD data → [www.festo.com](http://www.festo.com)

GK – Standard slide / GP – Standard slide, protected

Size 220

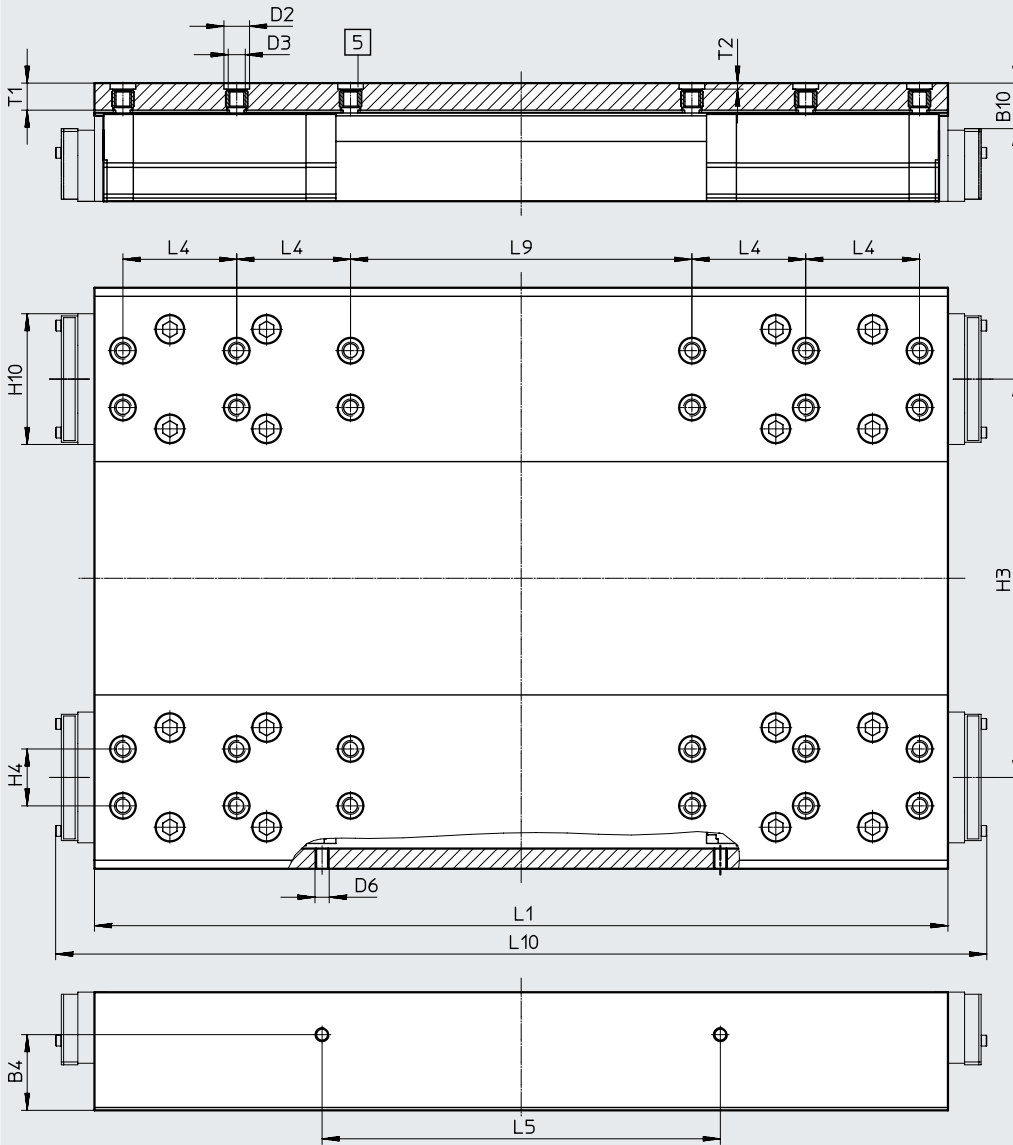

[5] Drilled hole for centring sleeve ZBH

Size	B4	B10*	D2 ∅ H7	D3	D6	H3	H4	H10*
220	±0.1 26.6	16	9	M6	M5	±0.05 140	±0.03 20	45.95

Size	L1	L4	L5	L9	L10*	T1	T2
220	±0.1 302	±0.03 40	±0.1 140	±0.03 120	328	9.5	+0.1 2.1

\* Protected version

Data sheet

Dimensions

Download CAD data → [www.festo.com](http://www.festo.com)

GK-C – Standard slide with lubrication adapter

Size 125

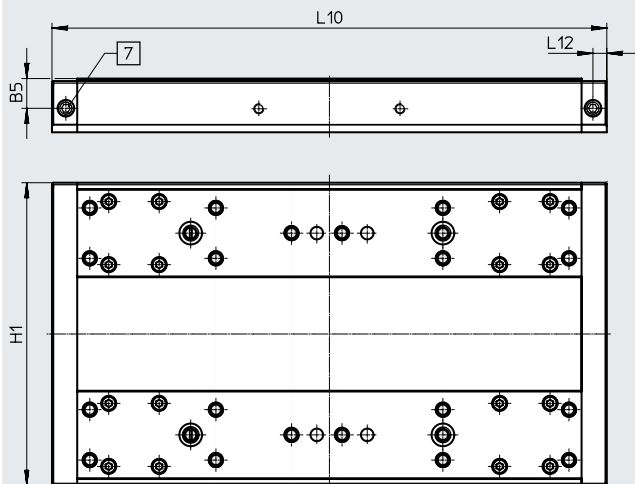

Size 160

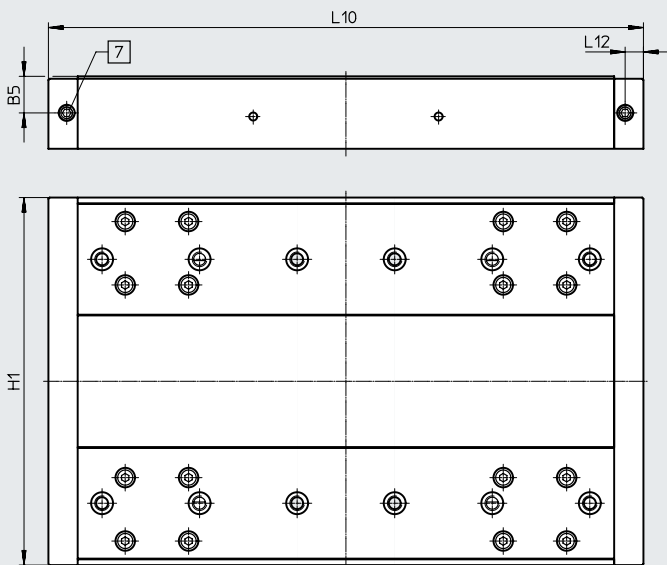

Size 220

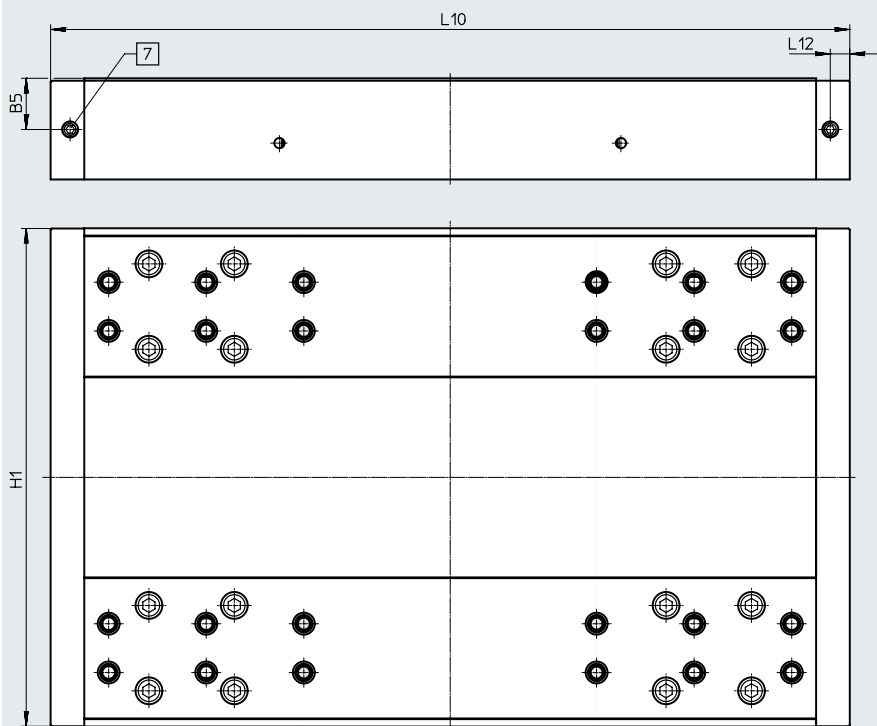

[7] Lubricating hole for lubrication adapter M6 threaded connection, 7 mm deep

Size	B5	H1	L10	L12
125	11.8	120	220	5.5
160	15	150.7	244	7.5
220	21	204	327.6	8



## Data sheet

## Dimensions

Download CAD data → [www.festo.com](http://www.festo.com)

M1/M2 – With incremental displacement encoder

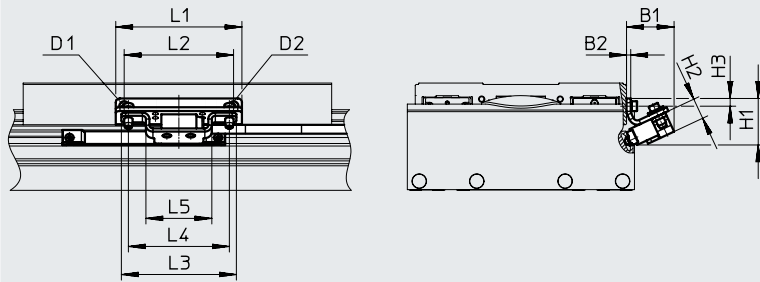
Encoder cable  
(Connection to motor controller/  
safety system) → page 37

Size	B1	B2	D1	D2	H1	H2
125	30.4	3	M4x8	M4x14	28.3	15
160	33.9	3	M4x8	M4x14	33.2	15
220	35.7	3	M5x10	M4x14	40.9	15

Size	H3	L1	L2	L3	L4	L5
125	5	108.5	56	82	72	47
160	5.5	90	76	82	72	47
220	7.5	170	140	82	72	47

## Ordering data – Modular product system

### Orientation guide

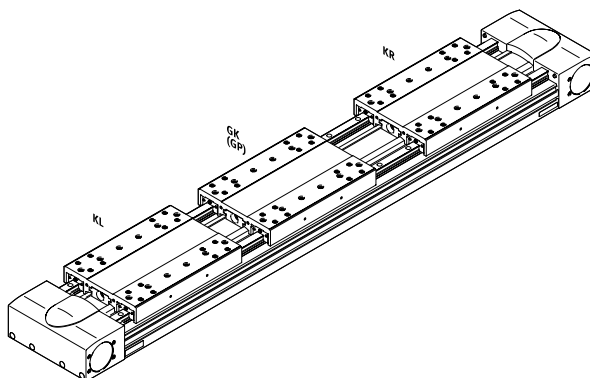
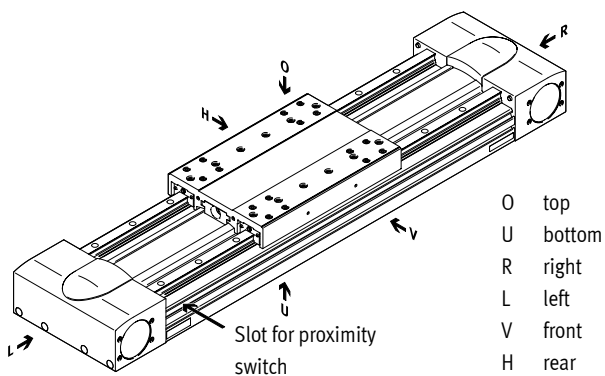

### Accessories

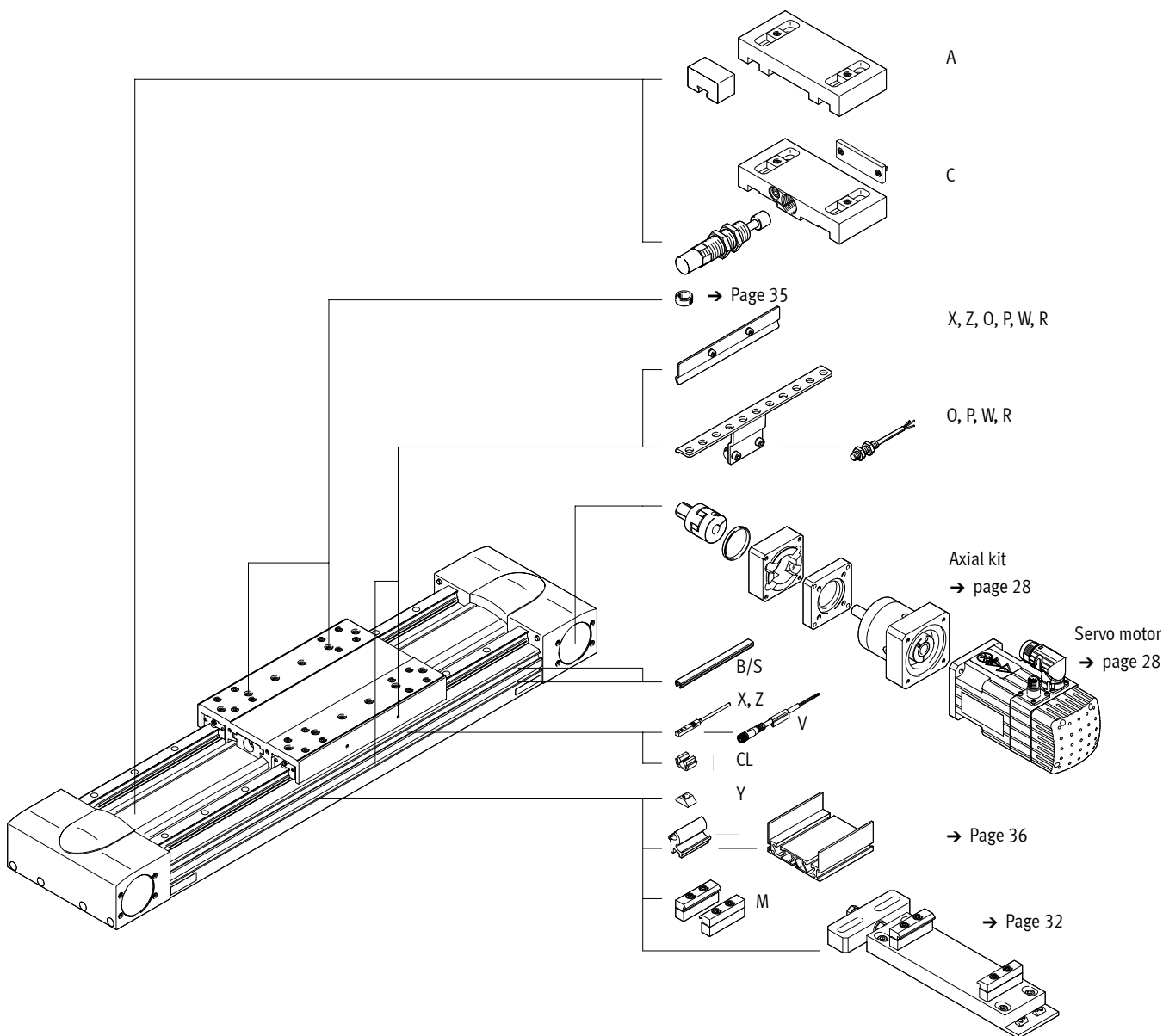

## Ordering data – Modular product system

Ordering table		125	160	220	Conditions	Code	Enter code
Size							
Module no.		<b>556823</b>	<b>556824</b>	<b>556825</b>			
Design		Linear axis				<b>EGC</b>	EGC
Guide		Heavy-duty guide				<b>-HD</b>	-HD
Size		125	160	220		-...	-...
Stroke length	[mm]	50 ... 3000	50 ... 5000	50 ... 4750	[1]	-...	-...
Function		Toothed belt				<b>-TB</b>	-TB
Stroke reserve	[mm]	0 ... 999 (0 = no stroke reserve)			[1]	<b>-...H</b>	
Slide		Standard slide				<b>-GK</b>	
		-	Standard slide, protected			<b>-GP</b>	
Additional slide	Left	Additional slide, standard, left			[2]	<b>-KL</b>	
	Right	Additional slide, standard, right			[2]	<b>-KR</b>	
Material of toothed belt		Chloroprene rubber					
		Coated PU				<b>-PU2</b>	
Lubrication function		Without					
		Lubrication adapter			[5]	<b>-C</b>	
Measurement system		Without					
		With displacement encoder, incremental, 2.5 µm				<b>-M1</b>	
		With displacement encoder, incremental, 10 µm				<b>-M2</b>	
Displacement encoder attachment position		Without					
		Rear			[6]	<b>-B</b>	
		Front			[6]	<b>-F</b>	
Accessories		Accessories enclosed separately				<b>ZUB-</b>	ZUB-
Profile mounting		1 ... 50				<b>...M</b>	
Slot cover	Mounting slot	1 ... 50 (1 = 2 units, 500 mm length)			[4]	<b>...B</b>	
	Sensor slot	1 ... 50 (1 = 2 units, 500 mm length)				<b>...S</b>	
Slot nut for mounting slot		1 ... 99			[4]	<b>...Y</b>	
Proximity switch (SIES), inductive, slot type 8, PNP, including switch lug	N/O contact, 7.5 m cable	1 ... 6				<b>...X</b>	
	N/C contact, 7.5 m cable	1 ... 6				<b>...Z</b>	
Emergency buffer with retaining bracket		1 ... 2			[3]	<b>...A</b>	
Shock absorber with retaining bracket		1 ... 2			[3]	<b>...C</b>	
Proximity sensor (SIEN), inductive, M8, PNP, including switch lug with sensor bracket	N/O contact, 2.5 m cable	1 ... 99				<b>...O</b>	
	N/C contact, 2.5 m cable	1 ... 99				<b>...P</b>	
	N/O contact, M8 plug	1 ... 99				<b>...W</b>	
	N/C contact, M8 plug	1 ... 99				<b>...R</b>	
Connecting cable, M8, 3-wire, 2.5 m		1 ... 99				<b>...V</b>	
Cable clip		10, 20, 30, 40, 50, 60, 70, 80, 90				<b>...CL</b>	

- [1] -... The sum of nominal stroke and 2x stroke reserve must not exceed the maximum stroke length.
- [2] KL, KR If the protected slide variant (GP) is selected, the additional slide (KL, KR) is also protected. If the slide with lubrication adapter (GK-C) is selected, then the additional slide (KL, KR) is also supplied with lubrication adapter
- [3] ... A, ... C Cannot be combined with slide GP
- [4] B, Y Included in the scope of delivery with size 160 for both slot sizes (→ page 35).
- [5] C Cannot be combined with GP, ...C, O, P, W, R, V
- [6] B, F Mandatory in combination with (measurement system) M1, M2  
Only in combination with (measurement system) M1, M2

## Accessories

 **Note**

Depending on the combination of motor and drive, it may not be possible to reach the maximum feed force of the drive.

**Permissible axis/motor combinations with axial kit**

Data sheets → Internet: eamm-a

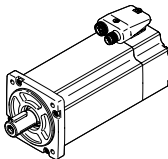
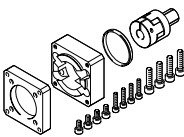
Motor/gear unit <sup>1)</sup>	Axial kit	
		<ul style="list-style-type: none"> <li>Kits for third-party motors → Internet: eamm-a</li> </ul>
Type	Part no.	Type
<b>EGC-HD-125</b>		
<b>With servo motor and gear unit</b>		
EMMT-AS-60-..., EMME-AS-60-... EMGA-60-P-G...-EAS-60	1456612	EAMM-A-M43-60H
<b>With stepper motor and gear unit</b>		
EMMS-ST-57-... EMGA-60-P-G...-SST-57	1190076	EAMM-A-M43-60G
<b>With integrated drive and gear unit</b>		
EMCA-EC-67-... EMGC-60-...	1456612	EAMM-A-M43-60H

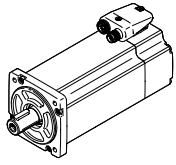
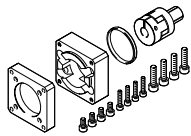

1) The input torque must not exceed the max. permissible transferable torque of the axial kit.

## Accessories

Permissible axis/motor combinations with axial kit		Data sheets → Internet: eamm-a	
Motor/gear unit <sup>1)</sup>	Axial kit		
	 <ul style="list-style-type: none"> <li>Kits for third-party motors → Internet: eamm-a</li> </ul>		
Type	Part no.	Type	
<b>EGC-HD-160</b>			
<b>With servo motor and gear unit</b>			
EMMT-AS-60-..., EMME-AS-60-... EMGA-60-P-G...-EAS-60	1456614	EAMM-A-M48-60H	
EMMT-AS-80-..., EMME-AS-80-... EMGA-80-P-G...-EAS-80	1190421	EAMM-A-M48-80G	
EMMT-AS-100-..., EMME-AS-100-... EMGA-80-P-G...-SAS-100	1190421	EAMM-A-M48-80G	
<b>With stepper motor and gear unit</b>			
EMMS-ST-87-... EMGA-80-P-G...-SST-87	1190421	EAMM-A-M48-80G	
<b>With integrated drive and gear unit</b>			
EMCA-EC-67-... EMGC-60-...	1456614	EAMM-A-M48-60H	
<b>EGC-HD-220</b>			
<b>With servo motor and gear unit</b>			
EMMT-AS-100-..., EMME-AS-100-... EMGA-120-P-G...-SAS-100	1190774	EAMM-A-M80-120G	

1) The input torque must not exceed the max. permissible transferable torque of the axial kit.

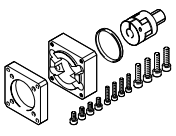
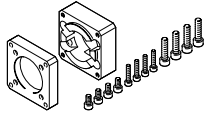
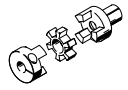
## Accessories

Permissible axis/motor combinations with axial kit			
Axial kit	Comprising:		
	Motor flange	Coupling	Centring ring
			
Part no. Type	Part no. Type	Part no. Type	Part no. Type
<b>EGC-HD-125</b>			
1190076 EAMM-A-M4360G	1597579 EAMF-A-43D-60G/H	558001 EAMD-32-32-11-16X20	575962 EAML-43-4-43
1456612 EAMM-A-M43-60H	1597579 EAMF-A-43D-60G/H	1377840 EAMD-32-32-14-16X20	575962 EAML-43-4-43
<b>EGC-HD-160</b>			
1456614 EAMM-A-M48-60H	1460111 EAMF-A-48C-60G/H	3420022 EAMD-42-40-14-16X25-U	558031 EAML-48-4-48
1190421 EAMM-A-M48-80G	1190375 EAMF-A-48C-80G	1781043 EAMD-42-40-20-16X25-U	558031 EAML-48-4-48
<b>EGC-HD-220</b>			
1190774 EAMM-A-M80-120G	1190702 EAMF-A-80A-120G	1781045 EAMD-56-46-25-23X27-U	1209006 EAML-80-6-80

## Accessories

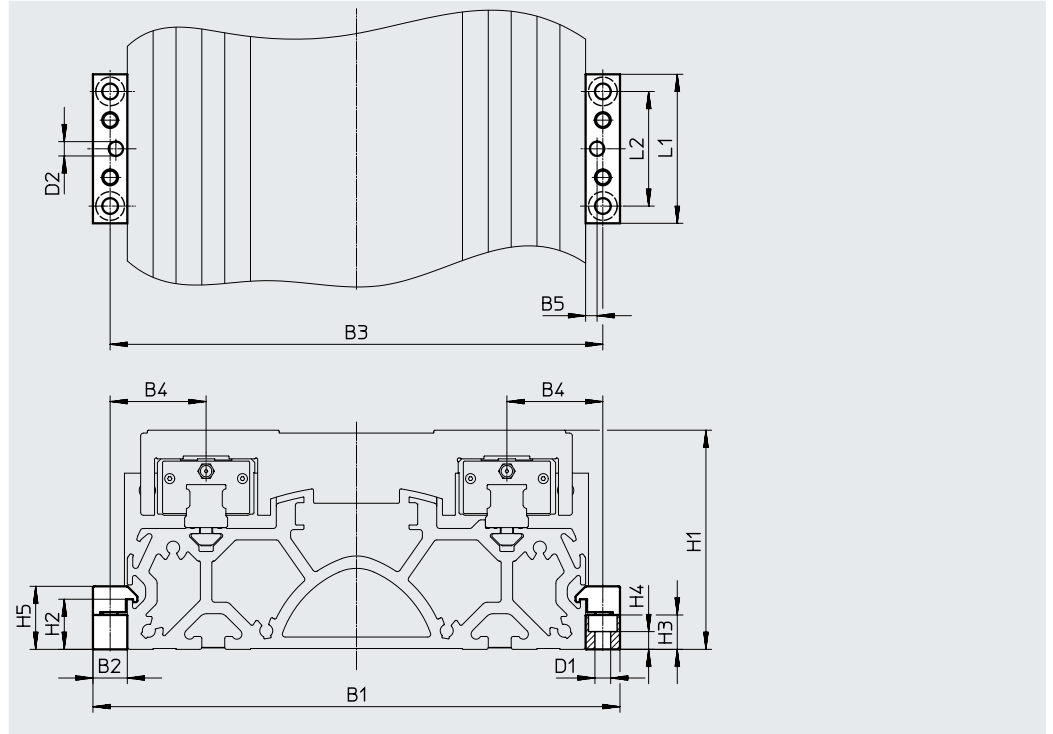
Profile mounting MUE  
(order code M)Material:  
Anodised aluminium  
RoHS-compliant

## Dimensions and ordering data

For size	B1	B2	B3	B4	B5	D1 ∅	D2 ∅ H7	H1	H2
125	146	12	134	27	4	5.5	5	64	17.5
160	184	12	172	33.5	4	5.5	5	76.5	17.5
220	258	19	239	49.5	4	9	5	111.5	16

For size	H3	H4	H5	L1	L2	Weight [g]	Part no.	Type
125	12	6.2	22	52	40	80	558043	MUE-70/80
160	12	6.2	22	52	40	80	558043	MUE-70/80
220	14	5.5	29.5	90	40	290	558044	MUE-120/185

Accessories

Adjusting kit EADC-E16

Material:  
Wrought aluminium alloy  
RoHS-compliant

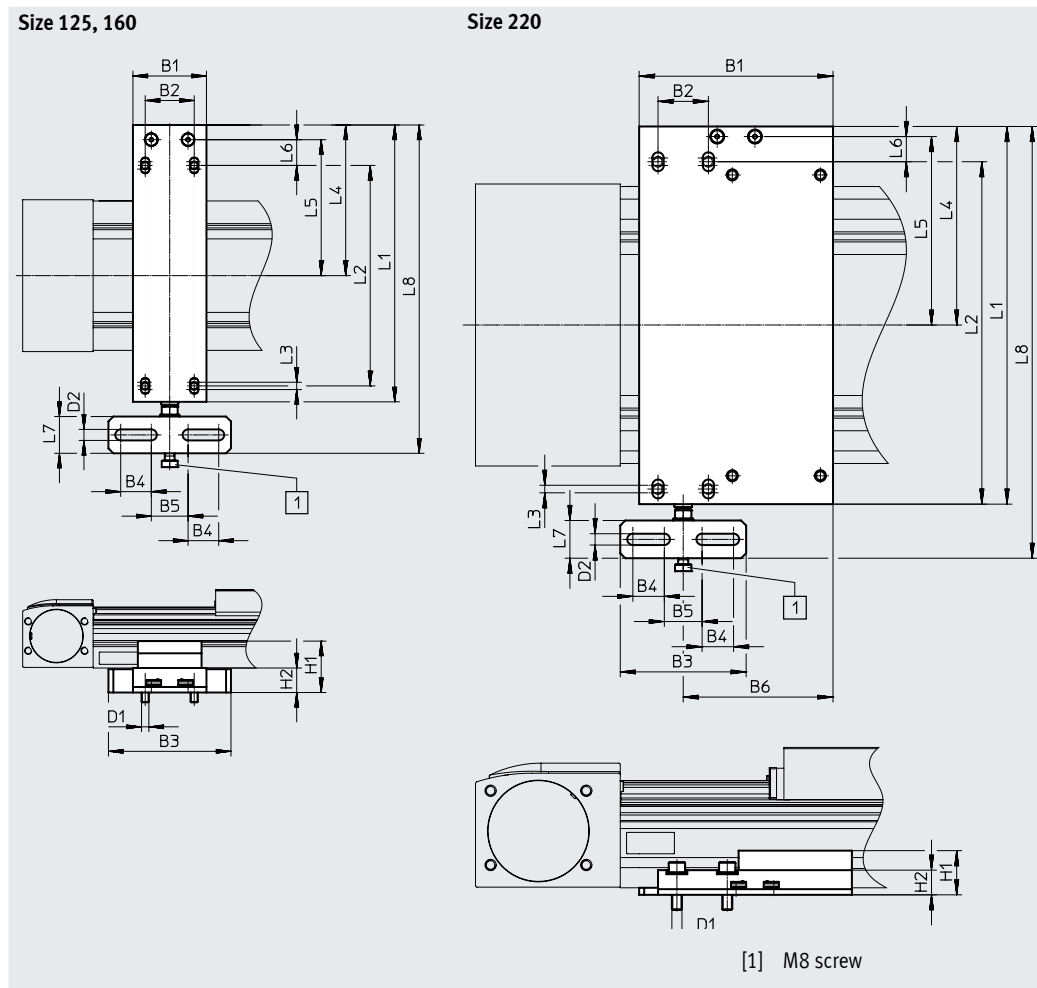
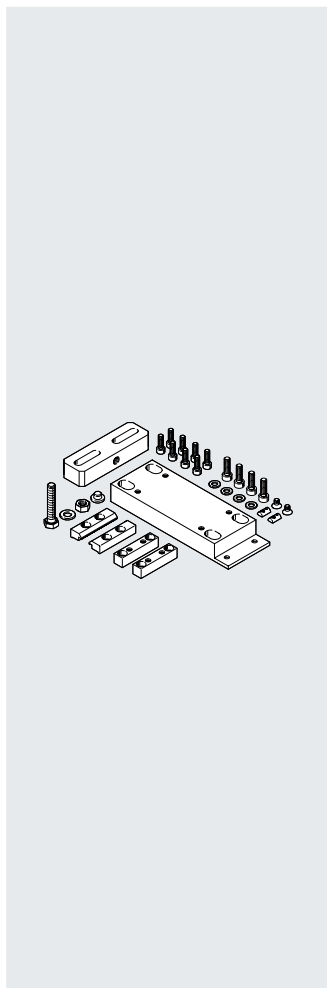

Dimensions and ordering data

For size	B1	B2	B3	B4	B5	B6	D1	D2	H1	H2	L1	L2
125	60	40	100	25	30	-	M6	9	42	20	226	180
160	60	40	100	25	30	-	M6	9	44	22	266	220
220	154	40	100	25	30	119	M8	9	35.1	19.6	300	260

For size	L3	L4	L5	L6	L7	L8	Weight [g]	Part no.	Type
125	6	123	111	21	30	308	974	8047580	EADC-E16-125-E14
160	6	143	131	21	30	343	1189	8047581	EADC-E16-160-E14
220	6	157.7	149.7	20	30	343	1500	8047582	EADC-E16-220-E14



Accessories

**Shock absorber retainer, retaining bracket EAYH**

Emergency buffer NPE → page 35  
 Shock absorber YSRW → page 35  
 (order code A or C)

Material:  
 Anodised aluminium  
 RoHS-compliant

Cannot be used in combination with the variants GP or C.

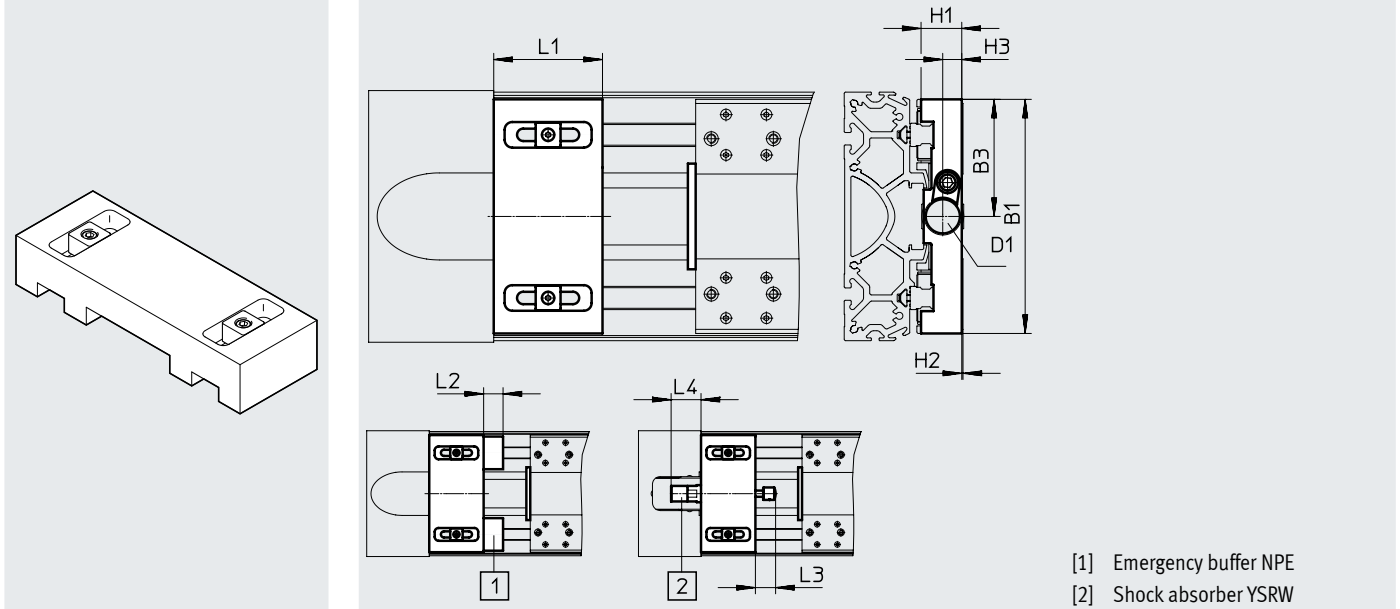

[1] Emergency buffer NPE  
 [2] Shock absorber YSRW

Dimensions and ordering data													
For size	B1	B3	D1	H1	H2	H3	L1	L2	L3	L4 min.	Weight [g]	Part no.	Type
<b>Shock absorber retainer</b>													
125	120	60	M16x1	19.8	0.4	9.7	50	-	20	36	286	1653251	EAYH-L2-125
160	150.7	75.3	M22x1.5	26.2	0.8	12.3	70	-	26	38.5	622	1653250	EAYH-L2-160
220	204	102	M26x1.5	38.7	0.1	15	70	-	34	63.5	1218	1653253	EAYH-L2-220
<b>Retaining bracket for emergency buffer</b>													
125	120	-	-	19.8	0.4	-	50	17	-	-	260	1662803	EAYH-L2-125-N
160	150.7	-	-	26.2	0.8	-	70	25	-	-	617	1669259	EAYH-L2-160-N
220	204	-	-	38.7	0.1	-	70	30	-	-	1195	1669260	EAYH-L2-220-N

**Switch lug SF-EGC-HD-1**

For sensing via proximity switch SIES-8M  
 (order code X or Z)

Material:  
 Galvanised steel  
 RoHS-compliant

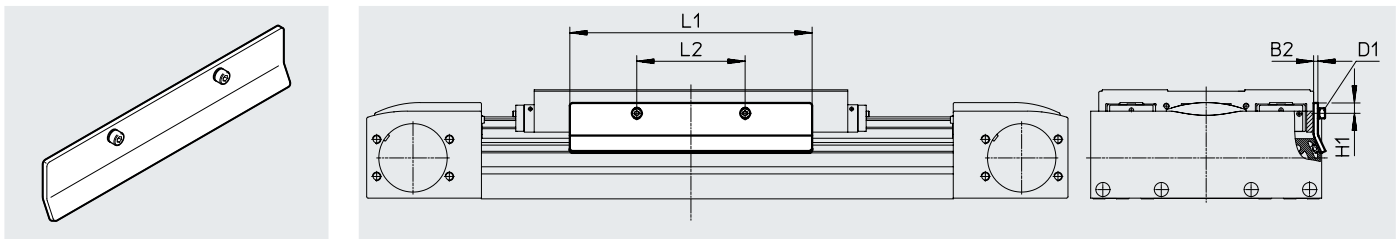

Dimensions and ordering data								
For size	B2	D1	H1	L1	L2	Weight [g]	Part no.	Type
125	2	M4x8	7.8	150	56	70	570027	SF-EGC-HD-1-125
160	3	M4x8	7.3	170	76	160	1645872	SF-EGC-HD-1-160
220	3	M5x10	11.5	250	140	310	1645866	SF-EGC-HD-1-220

## Accessories

### Switch lug SF-EGC-HD-2

For sensing via proximity switch SIEN-M8B (order code O, P, W or R) or SIES-8M (order code X or Z)

Material:  
Galvanised steel  
RoHS-compliant



### Sensor bracket HWS-EGC

For proximity switch SIEN-M8B (order code O, P, W or R)

Material:  
Galvanised steel  
RoHS-compliant

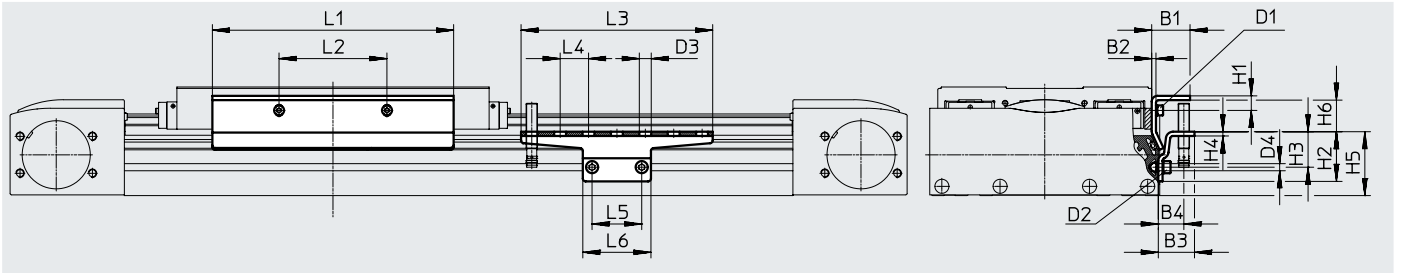

#### Dimensions and ordering data





For size	B1	B2	B3	B4	D1	D2	D3	D4	H1	H2
125	24	2	25.5	18	M4x8	M5x8	8.4	5.2	9	35
160	27	3	25.5	18	M4x8	M5x8	8.4	5.2	10.3	35
220	31	3	25.5	18	M5x10	M5x14	8.4	5.2	11.5	65

For size	H3	H4	H5	H6	L1	L2	L3	L4	L5	L6
125	25	3	45	14	150	56	135	20	35	48
160	25	3	45	22.2	170	76	135	20	35	48
220	55	3	75	18.4	250	140	215	20	35	48

For size	Weight [g]	Part no.	Type
Switch lug			
125	122	570030	SF-EGC-HD-2-125
160	261	1645865	SF-EGC-HD-2-160
220	430	1645868	SF-EGC-HD-2-220

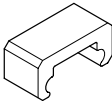
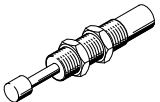
For size	Weight [g]	Part no.	Type
Sensor bracket			
125	110	558057	HWS-EGC-M5
160	110	558057	HWS-EGC-M5
220	217	570365	HWS-EGC-M8-B

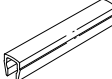
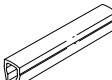
## Accessories

Ordering data	For size	Description	Order code	Part no.	Type	PJ <sup>1)</sup>
<b>Emergency buffer NPE</b>						
	125	Use in combination with retaining bracket EAYH	A	1662475	NPE-125	1
	160			1672593	NPE-160	
	220			1672598	NPE-220	
<b>Shock absorber YSRW</b>			Data sheets → Internet: ysrw			
	125	Use in combination with shock absorber retainer EAYH	C	191196	YSRW-12-20	1
	160			191197	YSRW-16-26	
	220			191198	YSRW-20-34	
<b>Slot nut NST</b>						
	125, 160 <sup>2)</sup>	For mounting slot	Y	150914	NST-5-M5	1
				8047843	NST-5-M5-10	10
				8047878	NST-5-M5-50	50
	160 <sup>3)</sup> , 220	For mounting slot	Y	150915	NST-8-M6	1
				8047868	NST-8-M6-10	10
				8047869	NST-8-M6-50	50
<b>Centring pin/sleeve ZBS/ZBH</b>						
	125	For slide	-	150928	ZBS-5	10
	125, 160, 220			8137184	ZBH-9-B	
<b>Slot cover ABP</b>						
	125, 160 <sup>2)</sup>	For mounting slot	B	151681	ABP-5	2
	160 <sup>3)</sup> , 220	Each 0.5 m		151682	ABP-8	
<b>Slot cover ABP-S</b>						
	125, 160, 220	For sensor slot Each 0.5 m	S	563360	ABP-5-S1	2
<b>Clip SMBK</b>						
	125, 160, 220	For sensor slot, for mounting the proximity switch cables	CL	534254	SMBK-8	10

1) Packaging unit

2) For mounting slot at the side

3) For mounting slot underneath

## Accessories

### Mounting options between axis and support profile

Depending on the adapter kit, the spacing between the axis and the support profile is:  
 $x = 20 \text{ mm}$  or  $50 \text{ mm}$

The support profile must be mounted using at least 2 adapter kits. For longer strokes, an adapter kit must be used every 500 mm.

Example

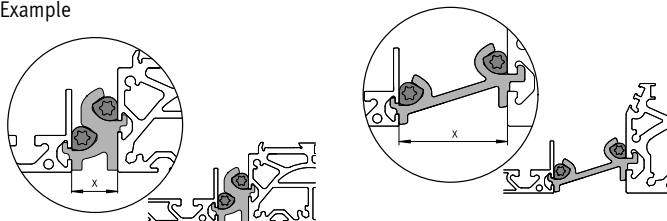





Ordering data					
	For size	Description	Part no.	Type	PU <sup>1)</sup>
<b>Adapter kit DHAM</b>					
	160	<ul style="list-style-type: none"> <li>For mounting the support profile on the axis</li> <li>Spacing between axis and profile is 20 mm</li> </ul>	562241	DHAM-ME-N1-CL	1
	220		562242	DHAM-ME-N2-CL	
	125, 160	<ul style="list-style-type: none"> <li>For mounting the support profile on the axis</li> <li>Spacing between axis and profile is 50 mm</li> </ul>	574560	DHAM-ME-N1-50-CL	
	220		574561	DHAM-ME-N2-50-CL	
<b>Support profile HMA</b>					
	70 ... 120	<ul style="list-style-type: none"> <li>For guiding an energy chain</li> </ul>	539379	HMA-E07-	1



1) Packaging unit

Ordering data – Proximity switches for T-slot, inductive							Data sheets → Internet: sies
	Type of mounting	Electrical connection	Switching output	Cable length [m]	Order code	Part no.	Type
<b>N/O contact</b>							
	Inserted in the slot from above, flush with the cylinder profile	Cable, 3-wire	PNP	7.5	X	551386	SIES-8M-PS-24V-K-7.5-OE
		Plug M8x1, 3-pin		0.3	–	551387	SIES-8M-PS-24V-K-0.3-M8D
		Cable, 3-wire	NPN	7.5	–	551396	SIES-8M-NS-24V-K-7.5-OE
		Plug M8x1, 3-pin		0.3	–	551397	SIES-8M-NS-24V-K-0.3-M8D
<b>N/C contact</b>							
	Inserted in the slot from above, flush with the cylinder profile	Cable, 3-wire	PNP	7.5	Z	551391	SIES-8M-PO-24V-K-7.5-OE
		Plug M8x1, 3-pin		0.3	–	551392	SIES-8M-PO-24V-K-0.3-M8D
		Cable, 3-wire	NPN	7.5	–	551401	SIES-8M-NO-24V-K-7.5-OE
		Plug M8x1, 3-pin		0.3	–	551402	SIES-8M-NO-24V-K-0.3-M8D

## Accessories

Ordering data – Proximity switch M8 (round design), inductive <sup>1)</sup>							Data sheets → Internet: sien
	Electrical connection	LED	Switching output	Cable length [m]	Order code	Part no.	Type
<b>N/O contact</b>							
	Cable, 3-wire	■	PNP	2.5	0	150386	SIEN-M8B-PS-K-L
			NPN	2.5	–	150384	SIEN-M8B-NS-K-L
	Plug M8x1, 3-pin	■	PNP	–	W	150387	SIEN-M8B-PS-S-L
			NPN	–	–	150385	SIEN-M8B-NS-S-L
<b>N/C contact</b>							
	Cable, 3-wire	■	PNP	2.5	P	150390	SIEN-M8B-PO-K-L
			NPN	2.5	–	150388	SIEN-M8B-NO-K-L
	Plug M8x1, 3-pin	■	PNP	–	R	150391	SIEN-M8B-PO-S-L
			NPN	–	–	150389	SIEN-M8B-NO-S-L

1) The proximity switches M8 (round design), inductive, cannot be combined with the central lubrication variant -C.

Ordering data – Connecting cables					Data sheets → Internet: nebu
	Electrical connection, left	Electrical connection, right	Cable length [m]	Part no.	Type
	Straight socket, M8x1, 3-pin	Cable, open end, 3-wire	2.5	159420	SIM-M8-3GD-2.5-PU
			2.5	541333	NEBU-M8G3-K-2.5-LE3
			5	541334	NEBU-M8G3-K-5-LE3
	Angled socket, M8x1, 3-pin	Cable, open end, 3-wire	2.5	541338	NEBU-M8W3-K-2.5-LE3
			5	541341	NEBU-M8W3-K-5-LE3

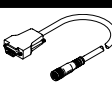
Ordering data – Encoder cables for displacement encoder system, EGC...-M1/-M2					Data sheets → Internet: nebm
	Electrical connection, left	Electrical connection, right	Cable length [m]	Part no.	Type
	Displacement encoder EGC...-M1/-M2	Motor controllers CMMP-AS and CMMT-AS	5.0	1599105	NEBM-M12G8-E-5-S1G9-V3
			10	1599106	NEBM-M12G8-E-10-S1G9-V3
			15	1599107	NEBM-M12G8-E-15-S1G9-V3
			X <sup>1)</sup>	1599108	NEBM-M12G8-E-...-S1G9-V3

1) Max. cable length 25 m.

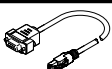
Ordering data – Adapter			
	Description	Part no.	Type
	Required in combination with the servo drive CMMT-AS as adapter between encoder cable NEBM-M12G8-...-V3 and interface X3 (position encoder 2)	8106112	NEFM-S1G9-K-0.5-R3G8